

# LS7 series

## Projector User Guide

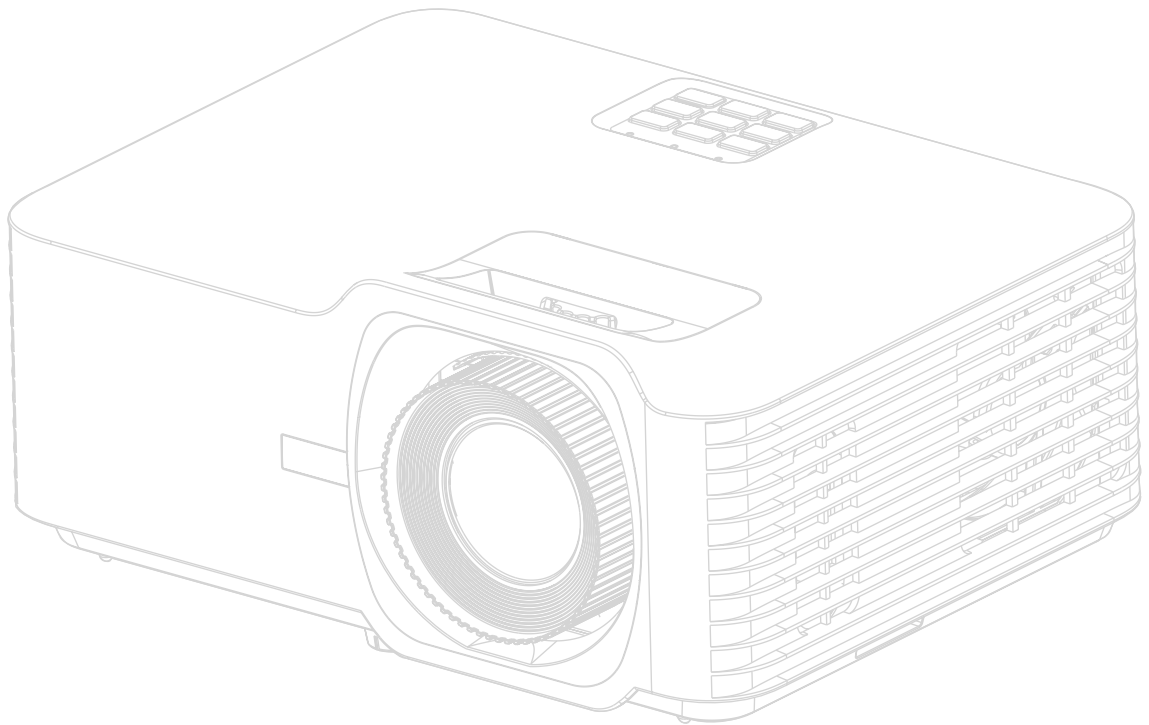

**IMPORTANT:** Please read this User Guide to obtain important information on installing and using your product in a safe manner, as well as registering your product for future service. Warranty information contained in this User Guide will describe your limited coverage from ViewSonic® Corporation, which is also found on our web site at <http://www.viewsonic.com> in English, or in specific languages using the Regional selection box on our website.

Model No. VS19701

## **Thank you for choosing ViewSonic®**

As a world-leading provider of visual solutions, ViewSonic® is dedicated to exceeding the world's expectations for technological evolution, innovation, and simplicity. At ViewSonic®, we believe that our products have the potential to make a positive impact in the world, and we are confident that the ViewSonic® product you have chosen will serve you well.

Once again, thank you for choosing ViewSonic®!

# Safety Precautions

Please read the following **Safety Precautions** before you start using the projector.

- Keep this user guide in a safe place for later reference.
- Read all warnings and follow all instructions.
- Allow at least 20" (50 cm) clearance around the projector to ensure proper ventilation.
- Place the projector in a well-ventilated area. Do not place anything on the projector that prevents heat dissipation.
- Do not place the projector on an uneven or unstable surface. The projector may fall over, causing personal injury or projector malfunction.
- Do not look straight at the projector lens during operation. The intense light beam may damage your eyes.
- Always open the lens shutter or remove the lens cap when the projector lamp is on.
- Do not block the projection lens with any objects when the projector is under operation as this could cause objects to become heated and deformed or even cause a fire.
- Do not attempt to disassemble the projector. There are dangerous high voltages inside which may cause death if you should come into contact with live parts.
- When moving the projector, be careful not to drop or bump the projector on anything.
- Do not place any heavy objects on the projector or connection cables.
- Avoid exposing the projector to direct sunlight or other sources of sustained heat. Do not install near any heat sources such as radiators, heat registers, stoves, or other devices (including amplifiers) that may increase the temperature of the projector to dangerous levels.
- Do not place liquids near or on the projector. Liquids spilled into the projector may cause it to fail. If the projector does become wet, disconnect it from the power supply and call your local service center to have the projector serviced.
- When the projector is under operation, you may sense some heated air and odor from its ventilation grill. It is a normal operation and not a defect.
- Do not attempt to circumvent the safety provisions of the polarized or grounding-type plug. A polarized plug has two blades with one wider than the other. A grounding-type plug has two blades and a third grounding prong. The wide and third blade are provided for your safety. If the plug does not fit into your outlet, obtain an adapter and do not attempt to force the plug into the outlet.

- When connecting to a power outlet, DO NOT remove the grounding prong. Please ensure grounding prongs are NEVER REMOVED.
- Protect the power cord from being treaded upon or pinched, particularly at the plug, and at the point where it emerges from the projector.
- In some countries, the voltage is NOT stable. This projector is designed to operate safely within a voltage between 100 to 240 volts DC, but could fail if power cuts or surges of  $\pm 10$  volts occur. In areas where voltage may fluctuate or cut out, it is recommended that you connect your projector through a power stabilizer, surge protector, or uninterruptable power supply (UPS).
- If smoke, an abnormal noise, or a strange odor is present, immediately switch the projector off and call your dealer or ViewSonic®. It is dangerous to continue using the projector.
- Use only attachments/accessories specified by the manufacturer.
- Disconnect the power cord from the DC outlet if the projector is not being used for a long period of time.
- Refer all servicing to qualified service personnel.



**CAUTION:** Possibly hazardous optical radiation is emitted from this product. As with any bright light source, do not stare into the beam, RG2 IEC 62471-5:2015. Additional warning against eye exposure for close exposures less than 1 m.

# Safety Precautions - Ceiling Mounting

Please read the following **Safety Precautions** before you start using the projector.

If you intend to mount the projector on the ceiling, it is strongly recommended that you use a proper fitting projector ceiling mount kit and that you ensure it is securely and safely installed.

If you use an inappropriate projector ceiling mount kit, there is a safety risk that the projector may fall from the ceiling due to an improper attachment through the use of the wrong gauge or length screws.

## Laser Caution

This product belongs to CLASS I laser product and complies with IEC 60825-1:2014, EN 60825-1:2014/A11:2021, EN 50689:2021.

IEC 60825-1:2014, EN 60825-1:2014+A11:2021, EN 50689:2021 CLASS 1 CONSUMER LASER  
PRODUCT RISK GROUP 2, Complies with 21 CFR 1040.10 and 1040.11 except for conformance as  
a Risk Group 2 LIP as defined in IEC 62471-5:Ed.1.0. For more information see Laser Notice No. 57,  
dated May 8, 2019.  
IEC 60825-1:2014 等級1雷射產品RG2危險等級  
IEC 60825-1:2014 1類激光產品RG2危險等級

Above laser cautions are located on the bottom of this apparatus.

- Notice is given to supervise children and to never allow them to stare into the projector beam at any distance from the projector.
- Notice is given to use caution when using the remote control for starting the projector while in front of the projection lens.
- Notice is given to the user to avoid the use of optical aids such as binoculars or telescopes inside the beam.

# Contents

<b>Safety Precautions.....</b>	<b>3</b>
<b>Introduction .....</b>	<b>9</b>
Package Contents .....	9
Product Overview .....	10
Projector.....	10
Keypad.....	11
Indicator Lights.....	11
I/O Ports .....	12
Remote Control .....	13
<b>Initial Setup.....</b>	<b>17</b>
Choosing a Location - Projection Orientation.....	17
Projection Dimensions.....	18
Mounting the Projector .....	20
Using the Security Bar .....	20
<b>Making Connections .....</b>	<b>21</b>
Connecting to Power .....	21
Connecting to External Devices .....	22
HDMI Connection .....	22
Audio Connection.....	23
USB Connection.....	24
RS-232 Connection .....	25
<b>Using the Projector.....</b>	<b>26</b>
Starting Up the Projector.....	26
Selecting an Input Source .....	27
Adjusting the Projected Image .....	28
Adjusting the Projector’s Height and Projection Angle.....	28
Adjusting the Focus, Keystone, Lens Shift, and Zoom.....	29
Shutting Down the Projector .....	30

<b>Operating the Projector.....</b>	<b>31</b>
On-Screen Display (OSD) Menu .....	31
Menu Navigation .....	32
On-Screen Display (OSD) Menu Tree.....	33
Menu Operation .....	39
Display Menu.....	39
Audio Menu.....	45
Setup Menu.....	46
Information Menu.....	49
<b>Appendix.....</b>	<b>50</b>
Specifications.....	50
Projector Dimensions .....	51
Timing Chart .....	52
HDMI PC Timing .....	52
HDMI Extended Wide Timing.....	52
3D Support Timing.....	53
Troubleshooting .....	54
LED Indicators.....	56
Maintenance.....	57
General Precautions .....	57
Cleaning the Lens .....	57
Cleaning the Case .....	57
Storing the Projector .....	57

<b>Regulatory and Service Information .....</b>	<b>58</b>
Compliance Information.....	58
FCC Compliance Statement.....	58
Industry Canada Statement.....	58
CE Conformity for European Countries.....	59
Declaration of RoHS2 Compliance.....	60
Indian Restriction of Hazardous Substances .....	61
Product Disposal at End of Product Life .....	61
Copyright Information .....	62
Customer Service .....	63
Limited Warranty .....	64
Mexico Limited Warranty.....	67



# Introduction

## Package Contents

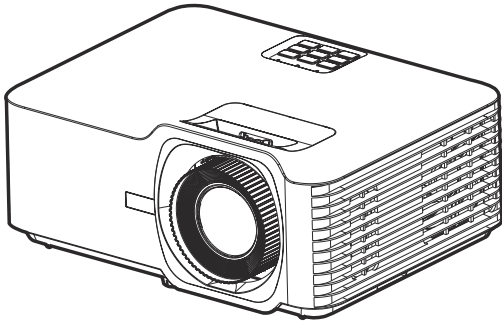

1



2



3



4

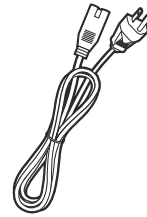

5

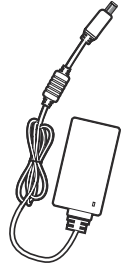

6

Number	Description
1	Projector
2	Remote Control
3	Batteries
4	Quick Start Guide
5	Power Cord
6	Power Adapter

**NOTE:** The power cord and remote control included in your package may vary depending on your country. Please contact your local reseller for more information.

# Product Overview

## Projector

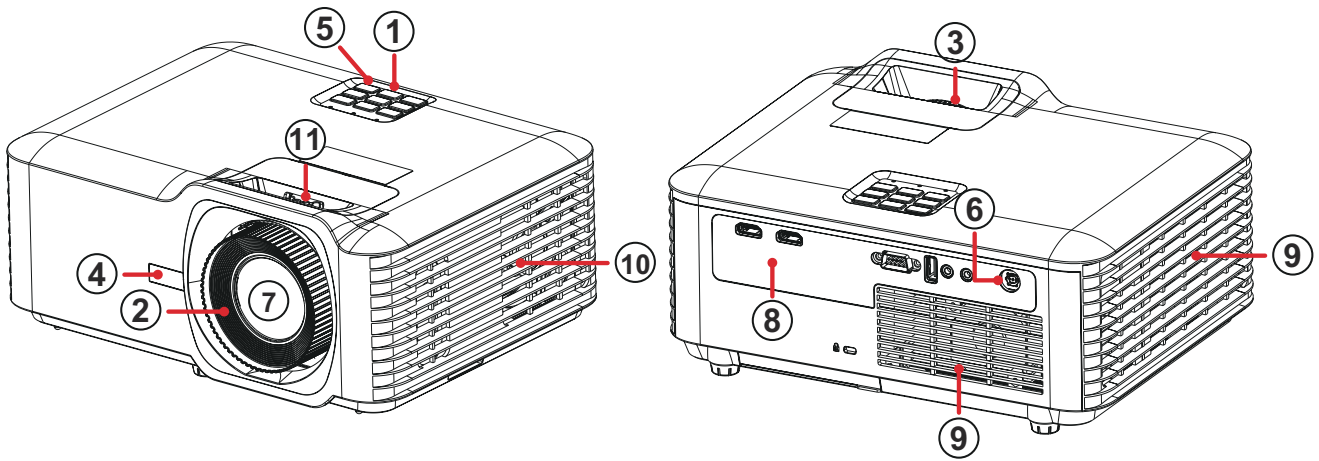

Number	Description
1	Keypad
2	Focus Ring
3	Zoom Ring
4	Front IR
5	Top IR
6	DC In
7	Lens
8	I/O Ports
9	Vent (inlet)
10	Vent (outlet)
11	Lens Shift

**NOTE:** Do not block projector intake and exhaust vents.

## Keypad

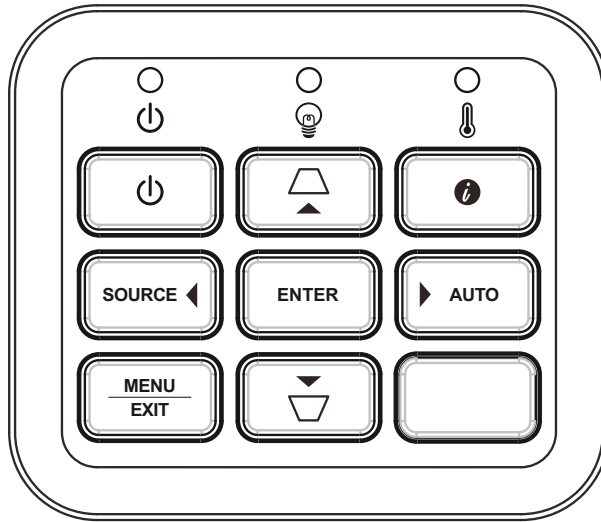

Key		Description
	<b>Power</b>	Toggles the projector between standby mode and Power On.
	<b>Keystone</b>	Manually corrects distorted images resulting from an angled projection.
	<b>Navigation</b>	Selects the desired menu items and makes adjustments when the On-Screen Display (OSD) Menu is activated.
	<b>Menu/Exit</b>	Opens/exits the On-Screen Display (OSD) Menu.
<b>SOURCE</b>	<b>Source</b>	Displays the input source selection bar.
	<b>Information</b>	Displays the INFORMATION menu.
<b>ENTER</b>	<b>Enter</b>	Enacts the selected On-Screen Display (OSD) Menu item when the OSD Menu is activated.
<b>AUTO</b>	<b>Auto</b>	Automatically determines the best picture timings for the displayed image.

## Indicator Lights

Indicator Light	Description
	Power indicator light
	Light source indicator light
	Temperature indicator light

## I/O Ports

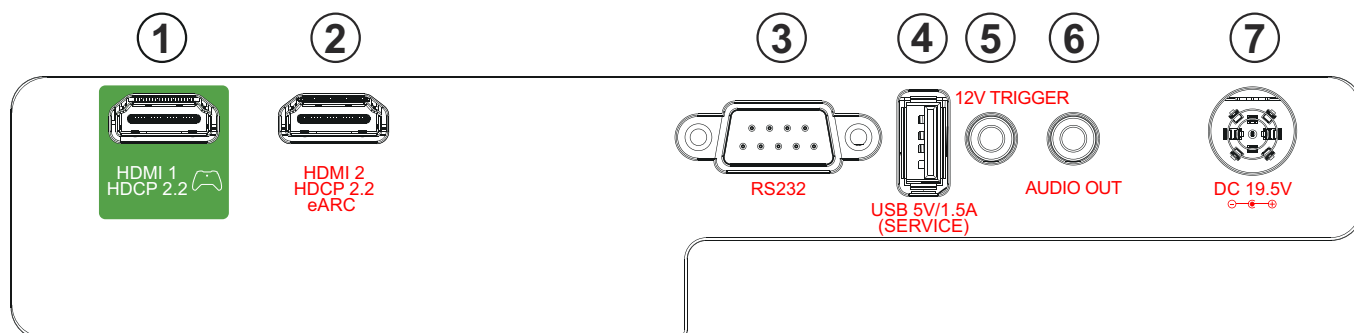









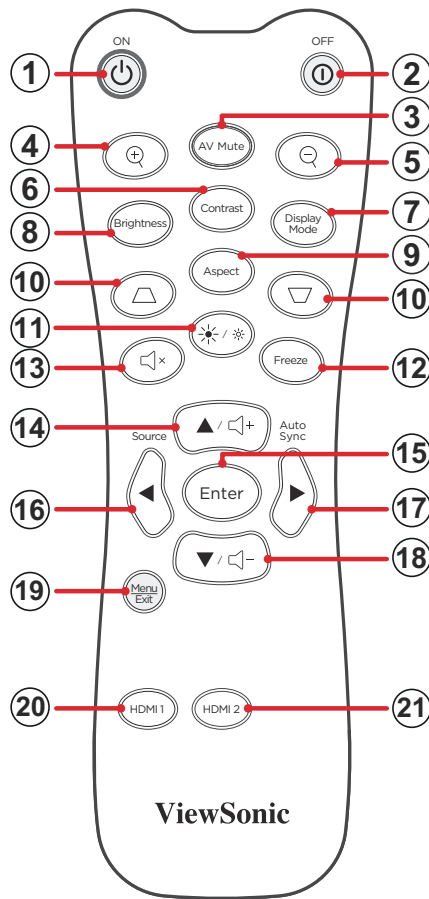



Port		Description
1	HDMI 1 <sup>1</sup>	HDMI port.
2	HDMI 2 <sup>1</sup>	HDMI port <sup>2</sup> .
3	RS-232	RS-232 control port.
4	USB (5V/1.5A Out) (Service)	USB Type A port for power and service.
5	12V Trigger	12V DC output terminal (500mA Out).
6	AUDIO OUT	Audio signal output socket.
7	DC IN	DC IN socket.











<sup>1</sup> Supports HDCP 2.2

<sup>2</sup> Supports eARC.

# Remote Control



Button		Description	
1	<b>Power ON</b>		Turns the projector ON
2	<b>Power OFF</b>		Turns the projector OFF
3	<b>AV Mute</b>		Hides the screen picture and volume mute.
4	<b>Zoom In</b>		Increases the projected image size.
5	<b>Zoom Out</b>		Reduces the projected image size.
6	<b>Contrast</b>		Displays the contrast selection bar.
7	<b>Display Mode</b>		Displays the display mode selection bar.
8	<b>Brightness</b>		Displays the brightness selection bar.
9	<b>Aspect</b>		Displays the aspect ratio selection bar.
10	<b>Keystone</b>	 	Manually correct distorted images.

Button		Description
11	<b>Brightness Mode</b> 	Displays the brightness mode selection bar.
12	<b>Freeze</b> 	Freeze the projected image.
13	<b>Mute</b> 	Mute/unmute.
14	<b>▲/Volume Increase</b> 	<ul style="list-style-type: none"> <li>• Navigate upwards.</li> <li>• Increase the volume level.</li> </ul>
15	<b>Enter</b> 	Confirms the selection.
16	<b>◀/Source</b> 	<ul style="list-style-type: none"> <li>• Navigate to the left.</li> <li>• Displays the input source selection bar.</li> </ul>
17	<b>▶/Auto Sync</b> 	<ul style="list-style-type: none"> <li>• Navigate to the right.</li> <li>• Automatically determines the best picture timings for the displayed image.</li> </ul>
18	<b>▼/Volume Decrease</b> 	<ul style="list-style-type: none"> <li>• Navigate downwards.</li> <li>• Decrease the volume level.</li> </ul>
19	<b>Menu/Exit</b> 	<ul style="list-style-type: none"> <li>• Turns the On-Screen Display (OSD) Menu On or Off.</li> <li>• Go back to a previous OSD Menu.</li> <li>• Exit and Save menu settings.</li> </ul>
20	<b>HDMI 1</b> 	Select the <b>HDMI 1</b> input source.
21	<b>HDMI 2</b> 	Select the <b>HDMI 2</b> input source.

## Remote Control - Receiver Range

To ensure proper function of the remote control follow the steps below:

1. The remote control must be held at an angle within 30° perpendicular to the projector's IR remote control sensor(s).
2. The distance between the remote control and the sensor(s) should not exceed 8 m (26 ft.)

**NOTE:** Refer to the illustration for the location of the infrared (IR) remote control sensor(s).

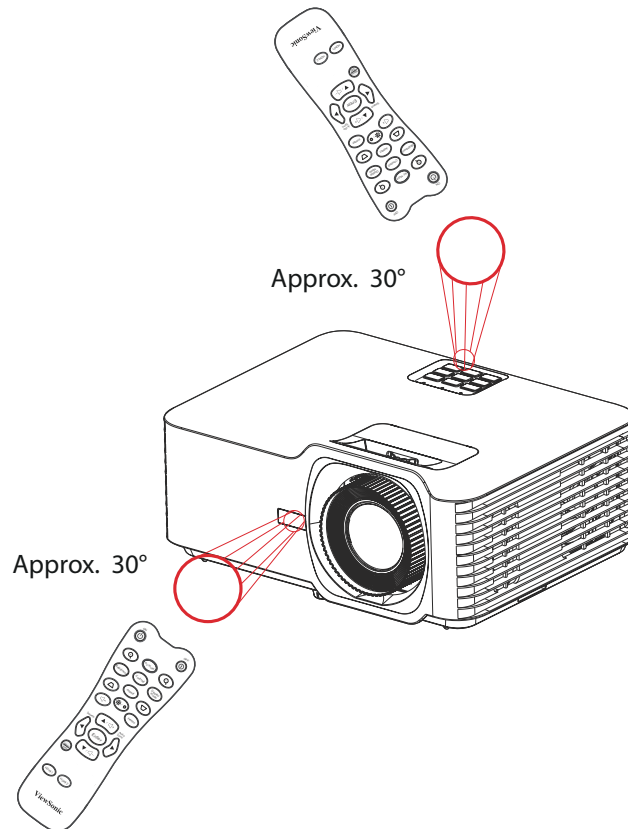

## Remote Control - Replacing the Batteries

1. Remove the battery cover from the bottom of the remote control by pressing the finger grip and sliding it across.
2. Remove any existing batteries (if necessary) and install two AAA batteries.

**NOTE:** Observe the battery's polarities as indicated.

3. Replace the battery cover by aligning it with the base and pushing it back into position.

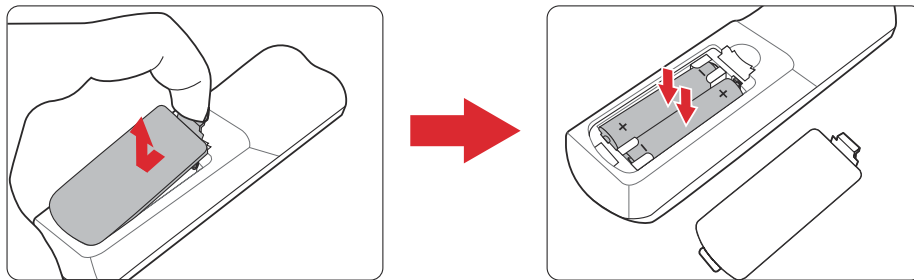

### NOTE:

- Avoid leaving the remote control and batteries in excessive heat or a humid environment.
- Replace only with the same or equivalent type recommended by the battery manufacturer.
- If the batteries are drained or if you will not be using the remote control for an extended period of time, remove the batteries to avoid damage to the remote control.
- Dispose of the used batteries according to the manufacturer's instructions and local environment regulations for your region.



# Initial Setup

This section provides detailed instructions for the initial set up your projector.

## Choosing a Location - Projection Orientation

Personal preference and room layout will decide the installation location. Consider the following:

- Size and position of your screen.
- Location of a suitable power outlet.
- Location and distance between the projector and other equipment.

The projector is designed to be installed in one of the following locations:

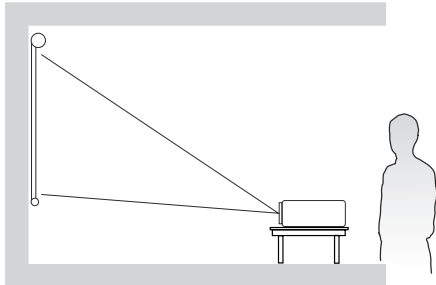
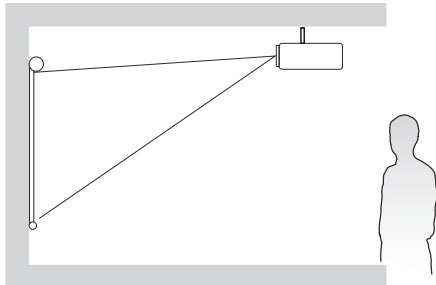
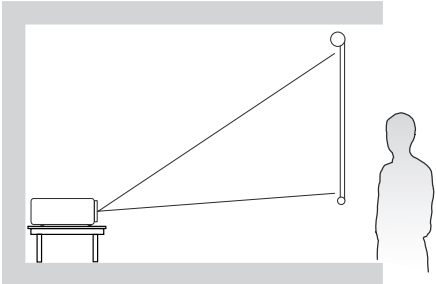
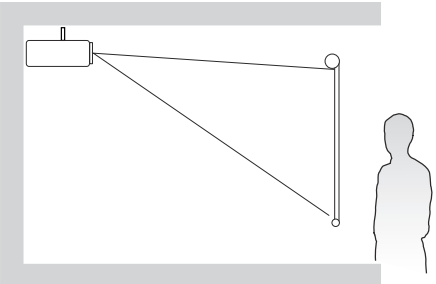
Location	
<p><b>Desk Front</b></p> <p>The projector is placed near the floor in front of the screen.</p>	
<p><b>Ceiling Front</b></p> <p>The projector is suspended upside-down from the ceiling in front of the screen.</p>	
<p><b>Desk Rear<sup>1</sup></b></p> <p>The projector is placed near the floor behind the screen.</p>	
<p><b>Ceiling Rear<sup>1</sup></b></p> <p>The projector is suspended upside-down from the ceiling behind the screen.</p>	

<sup>1</sup> A rear projection screen is required.

# Projection Dimensions

- 16:9 Image on a 16:9 Screen

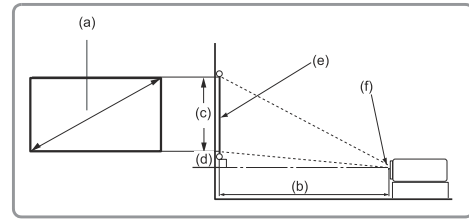
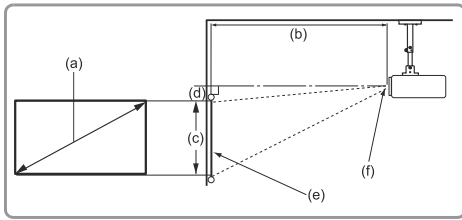

**NOTE:**

- (e) = Screen (f) = Center of Lens

(a) Screen Size		(b) Projection Distance				(c) Image Height		(d) Vertical Offset			
in.	mm	Minimum		Maximum				Minimum		Maximum	
in.	mm	in.	mm	in.	mm	in.	mm	in.	mm	in.	mm
30	762	27.72	704	37.91	963	14.71	374	0.0	0.0	2.74	69
40	1016	36.95	939	50.55	1284	19.61	498	0.0	0.0	3.65	93
50	1270	46.19	1173	63.19	1605	24.51	623	0.0	0.0	4.56	116
60	1524	55.43	1408	75.83	1926	29.42	747	0.0	0.0	5.47	139
70	1778	64.67	1643	88.46	2247	34.32	872	0.0	0.0	6.38	162
80	2032	73.91	1877	101.10	2568	39.22	996	0.0	0.0	7.30	185
90	2286	83.15	2112	113.74	2889	44.12	1121	0.0	0.0	8.21	208
100	2540	92.39	2347	126.38	3210	49.03	1245	0.0	0.0	9.12	232
110	2794	101.63	2581	139.02	3531	53.93	1370	0.0	0.0	10.03	255
120	3048	110.86	2816	151.65	3852	58.83	1494	0.0	0.0	10.94	278
130	3302	120.10	3051	164.29	4173	63.73	1619	0.0	0.0	11.85	301
140	3556	129.34	3285	176.93	4494	68.64	1743	0.0	0.0	12.77	324
150	3810	138.58	3520	189.57	4815	73.54	1868	0.0	0.0	13.68	347
200	5080	184.77	4693	252.76	6420	98.05	2491	0.0	0.0	18.24	463
250	6350	230.97	5867	315.95	8025	122.57	3113	0.0	0.0	22.80	579
300	7620	277.16	7040	379.14	9630	147.08	3736	0.0	0.0	27.36	695

**NOTE:**

- These figures are for reference purposes only. Please refer to the actual projector for the precise dimensions.
- It is recommended that if you intend to permanently install the projector to physically test the projection size and distance using the actual projector before you permanently install it.

- 16:9 Image on a 4:3 Screen

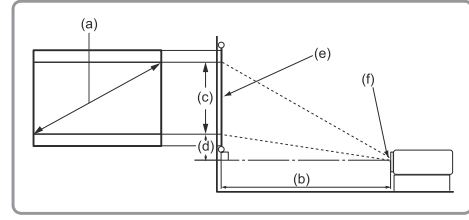
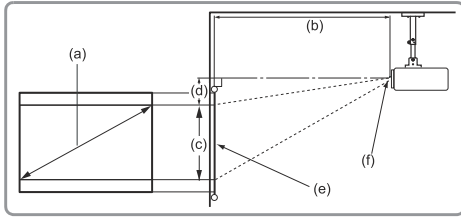

**NOTE:**

- (e) = Screen (f) = Center of Lens

(a) Screen Size		(b) Projection Distance				(c) Image Height		(d) Vertical Offset			
in.	mm	Minimum	Maximum	Minimum	Maximum	Minimum	Maximum	Minimum	Maximum	Minimum	Maximum
30	762	25.44	646	34.80	884	13.50	343	0.0	0.0	2.51	64
40	1016	33.92	862	46.40	1179	18.00	457	0.0	0.0	3.35	85
50	1270	42.40	1077	58.00	1473	22.50	572	0.0	0.0	4.19	106
60	1524	50.88	1292	69.60	1768	27.00	686	0.0	0.0	5.02	128
70	1778	59.36	1508	81.20	2062	31.50	800	0.0	0.0	5.86	149
80	2032	67.84	1723	92.80	2357	36.00	914	0.0	0.0	6.70	170
90	2286	76.32	1939	104.40	2652	40.50	1029	0.0	0.0	7.53	191
100	2540	84.40	2154	116.00	2946	45.00	1143	0.0	0.0	8.37	213
110	2794	93.28	2369	127.60	3241	49.50	1257	0.0	0.0	9.21	234
120	3048	101.76	2585	139.20	3536	54.00	1372	0.0	0.0	10.04	255
130	3302	110.24	2800	150.80	3830	58.50	1486	0.0	0.0	10.88	276
140	3556	118.72	3015	162.40	4125	63.00	1600	0.0	0.0	11.72	298
150	3810	127.20	3231	174.00	4420	67.50	1715	0.0	0.0	12.56	319
200	5080	169.60	4308	232.00	5893	90.00	2286	0.0	0.0	16.74	425
250	6350	212.00	5385	290.00	7366	112.50	2858	0.0	0.0	20.93	531
300	7620	254.40	6462	348.00	8839	135.00	3429	0.0	0.0	25.11	638

**NOTE:**

- These figures are for reference purposes only. Please refer to the actual projector for the precise dimensions.
- It is recommended that if you intend to permanently install the projector to physically test the projection size and distance using the actual projector before you permanently install it.

# Mounting the Projector

**NOTE:** If you buy a third party mount, please use the correct screw size. Screw size can vary depending on the thickness of the mounting plate.

1. To ensure the most secure installation, please use a ViewSonic® wall or ceiling mount.
2. Ensure the screws used to attach the mount to the projector meet the following specifications:
  - Screw type: M4 x 8
  - Maximum Screw Length: 8 mm
3. Place the power adapter within the designated area and secure it with a cable strap.

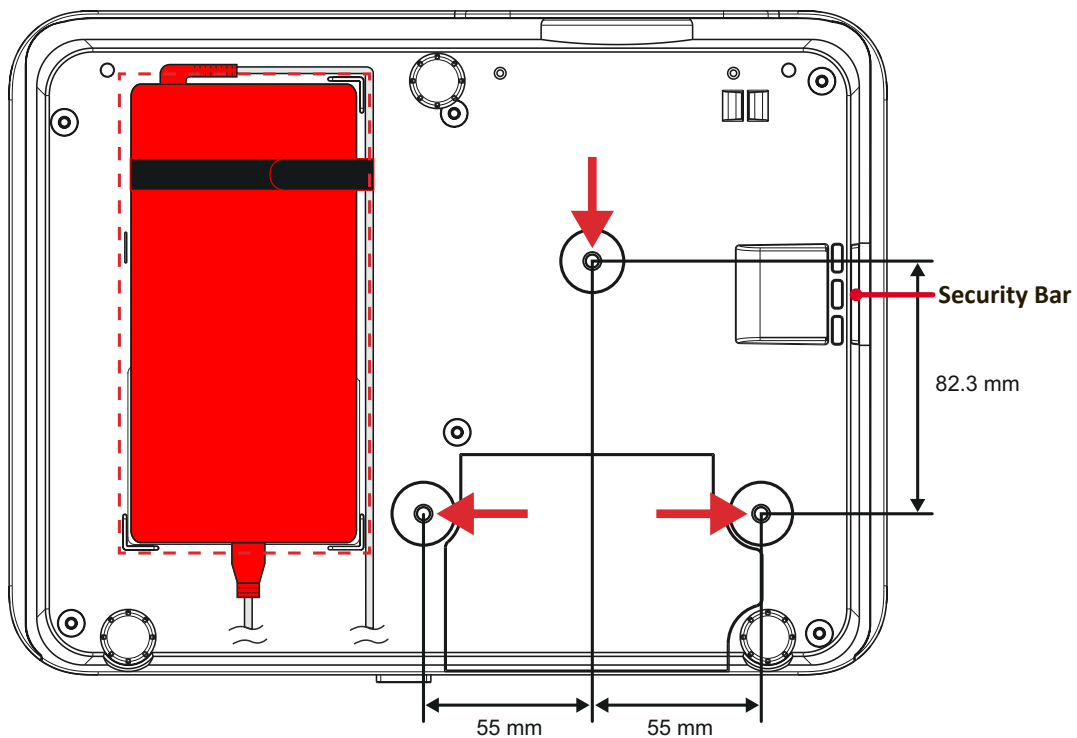

## CAUTION:

- Avoid installing the projector near a heat source or air conditioner.
- Keep at least a 10 cm (3.9 in.) gap between the ceiling and the bottom of the projector.

## Using the Security Bar

To help prevent the projector from being stolen, use a security slot locking device to secure the projector to a fixed object.

# Making Connections

## Connecting to Power

1. Connect the power cord to the power adapter.
2. Connect the power adapter to the DC IN jack at the rear of the projector.
3. Plug the power cord into a power outlet.

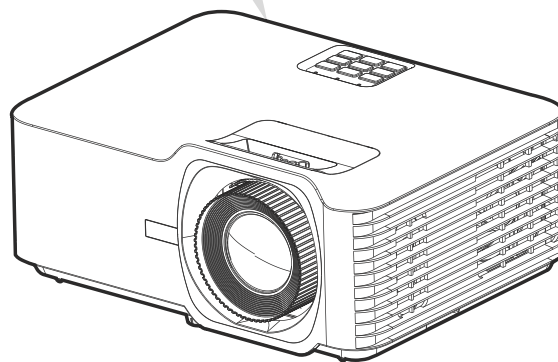
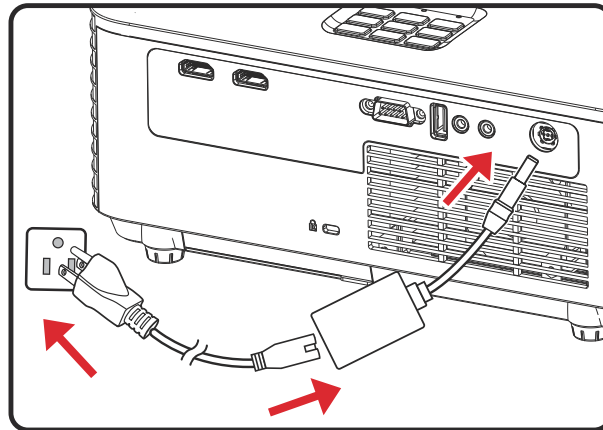

**NOTE:** When installing the projector, incorporate a readily accessible disconnect device in the fixed wiring, or connect the power plug to an easily accessible outlet near the unit. If a fault should occur during operation of the projector, use the disconnect device to switch off the power supply, or disconnect the power plug.

# Connecting to External Devices

## HDMI Connection

Connect one end of an HDMI cable to the HDMI port of your video device. Then connect the other end of the cable to the **HDMI 1/2** port (each support HDMI 2.0/HDCP 2.2) of your projector.

**NOTE:** The **HDMI 2** port supports eARC.

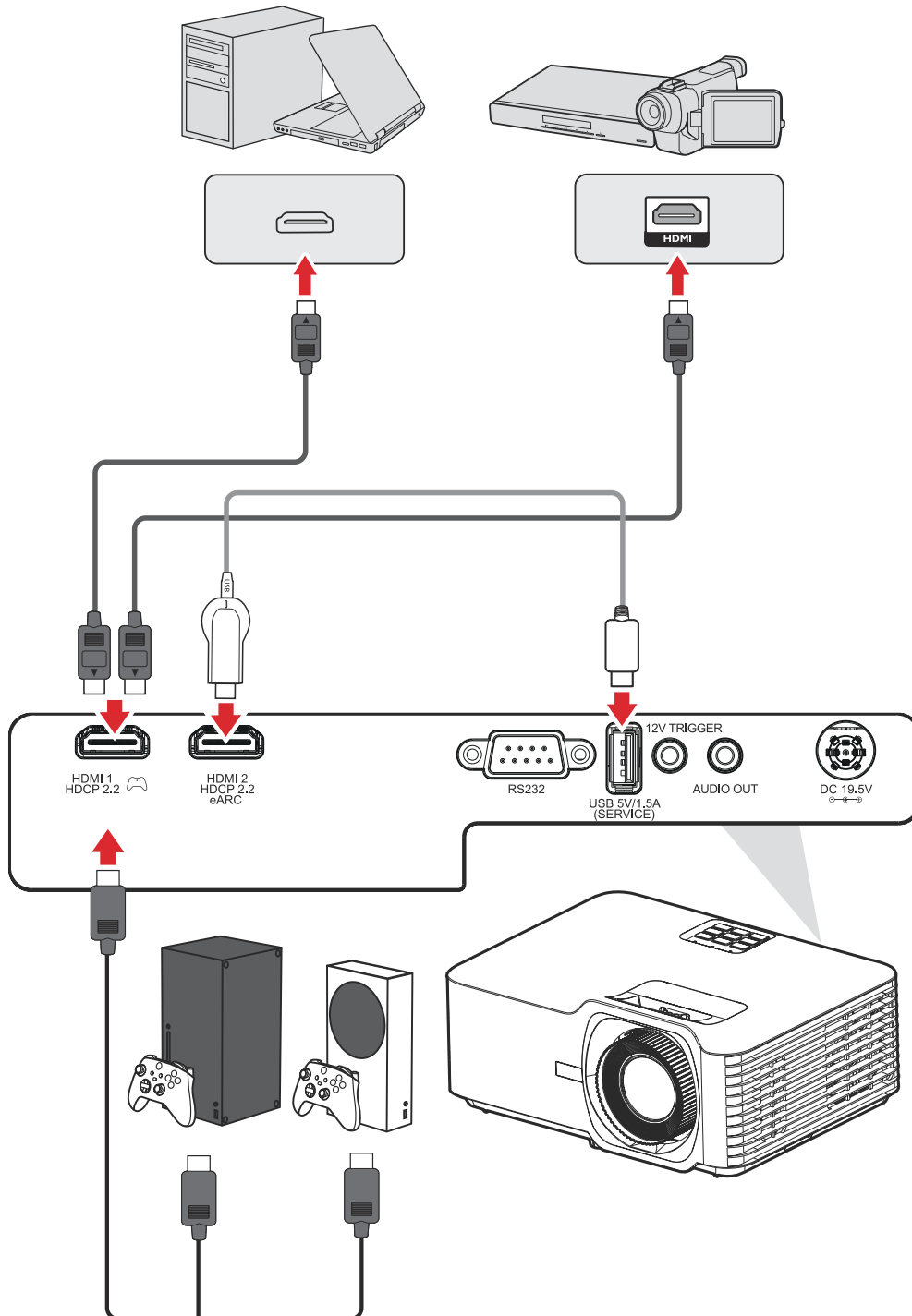

## Audio Connection

You can connect to various external sound delivery devices via the **AUDIO OUT** and **HDMI 2** ports.

**NOTE:** The **HDMI 2** port supports eARC. It can deliver sound to external devices when connected.

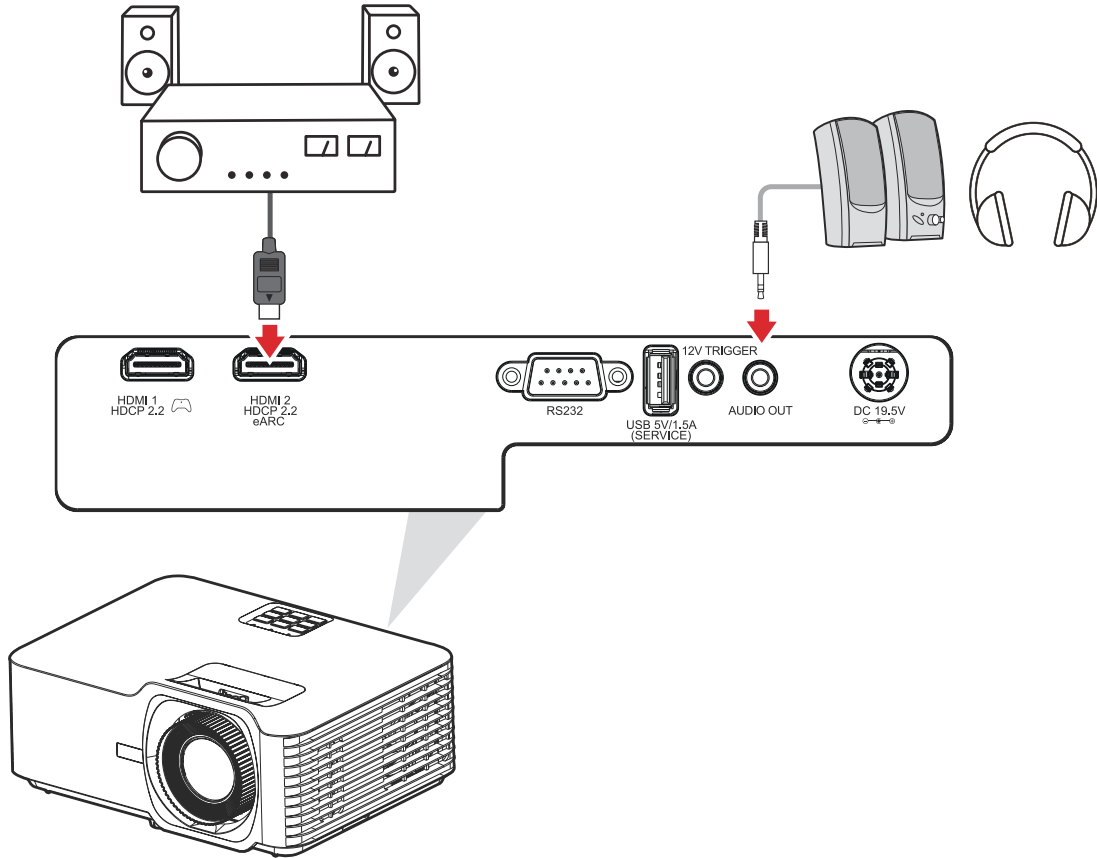

## USB Connection

### USB Type A Connection

The USB port is for supplying power (e.g., dongles) and service needs.

**NOTE:** The USB port does not supply power when the projector is in standby mode.

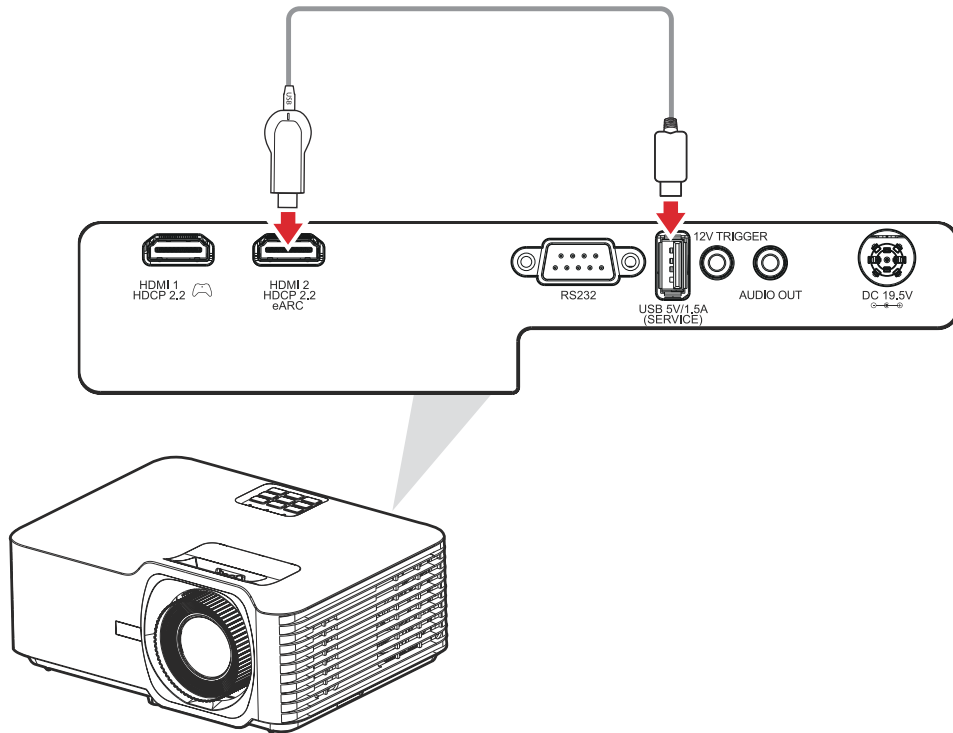



## RS-232 Connection

When you use a RS-232 serial port cable to connect the projector to an external computer certain functions can be controlled remotely by the PC, including Power On/Off, Volume adjustment, Input select, Brightness, and more.

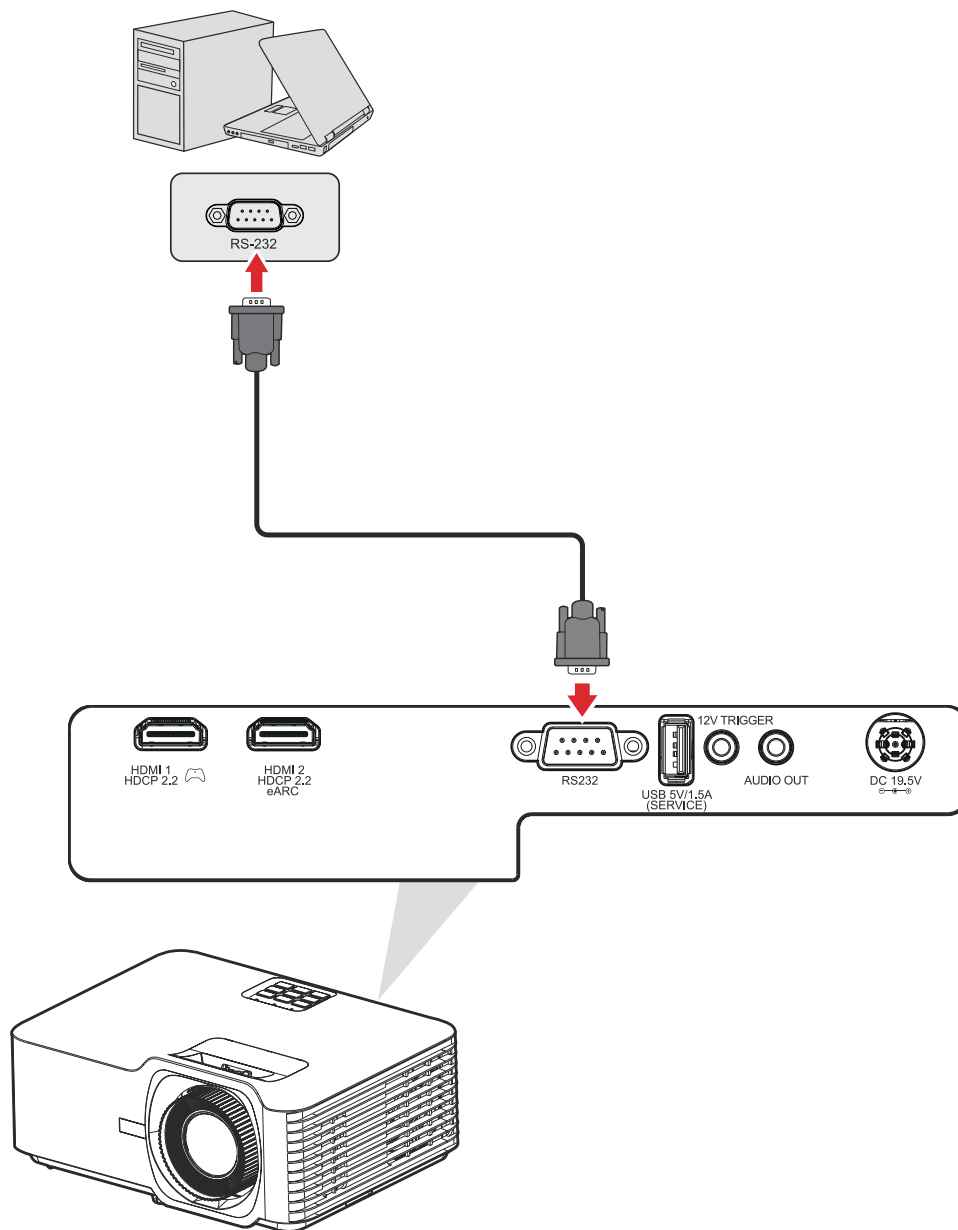

# Using the Projector

## Starting Up the Projector

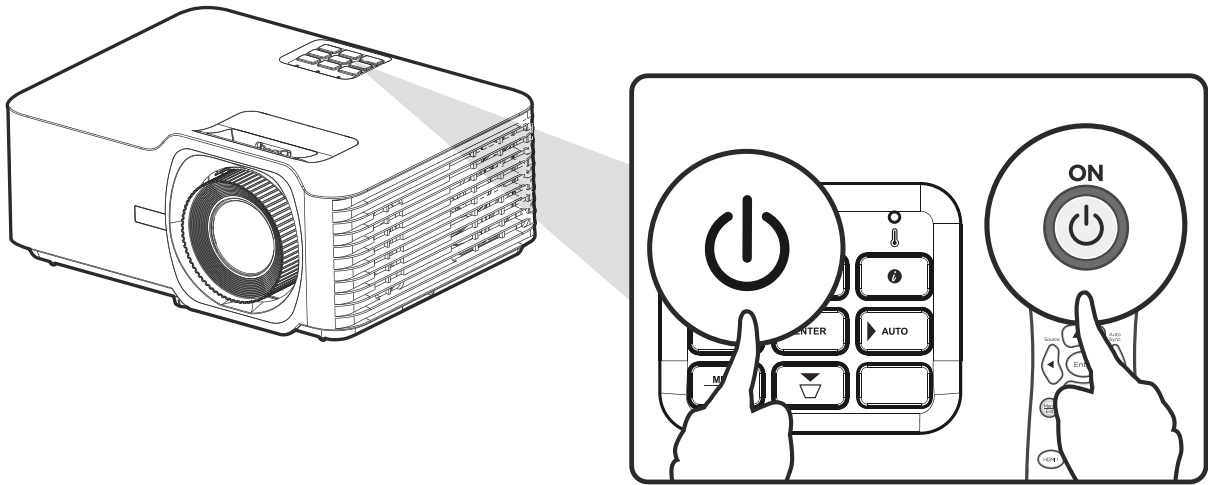

1. Ensure the projector's power cord is properly connected to a power outlet.
2. Press the **Power** button on the projector or remote control to turn on the projector.

### NOTE:

- The Power Indicator Light will be flashing blue during startup.
- The first time the projector is turned on, you will be prompted to select the preferred language and projection orientation.

## Selecting an Input Source

The projector can be connected to multiple devices at the same time. However, it can only display one full screen at a time.

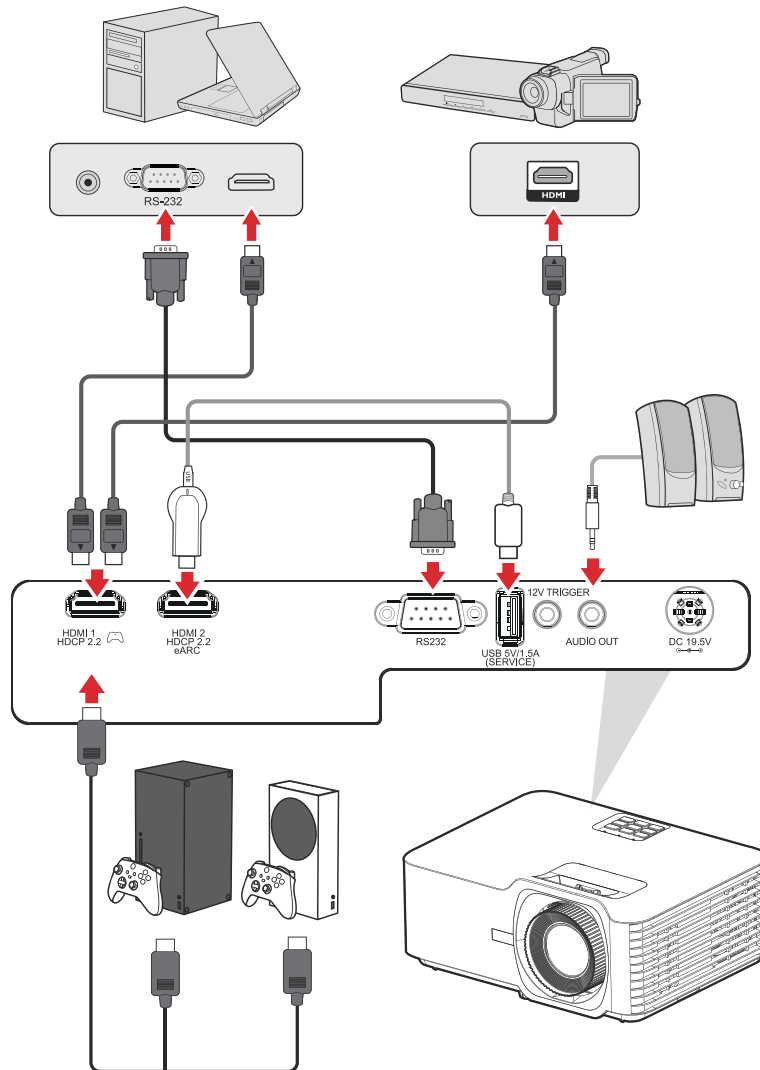

When **Auto Source** is On, the projector will automatically search for input sources. If multiple sources are connected, press the **Source** button on the projector or remote control to select the desired input.

**NOTE:** Ensure the connected sources are also turned on.

# Adjusting the Projected Image

## Adjusting the Projector's Height and Projection Angle

The projector is equipped with three (3) adjustment feet. Adjusting the feet will change the projector's height and the vertical projection angle.

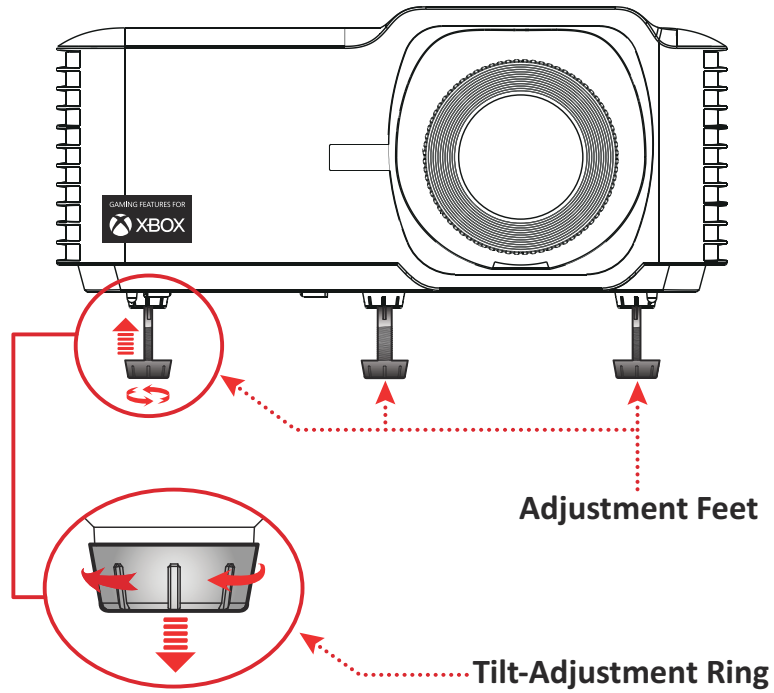

## Adjusting the Focus, Keystone, Lens Shift, and Zoom

You can improve and adjust the clarity and position of the image by adjusting the **Focus Ring**, **Keystone Keys**, **Lens Shift dial** or **Zoom Ring**.

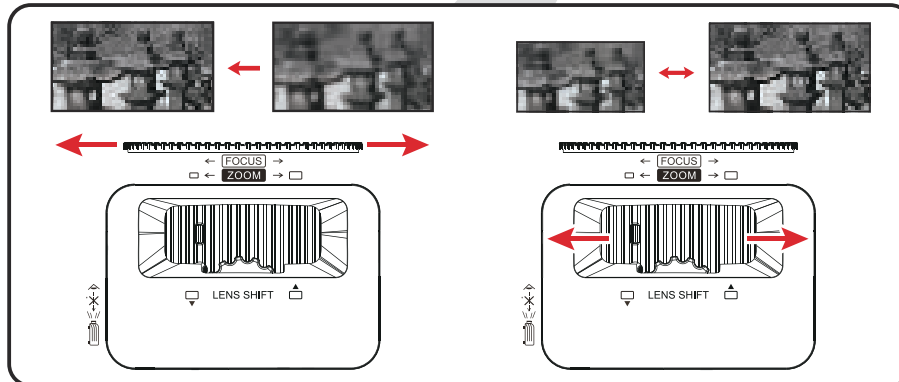
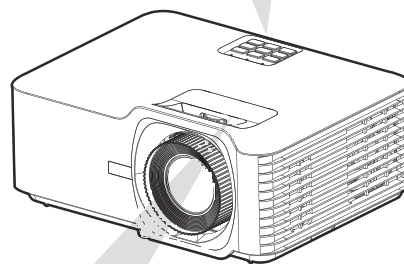
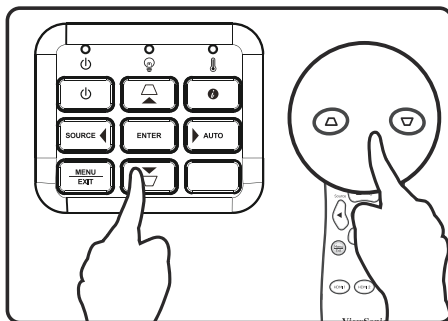

## Shutting Down the Projector



1. Press the **Power** button on the projector or remote control and a “power off message” will appear.
2. Press the **Power** button again to confirm and shut down the projector.
3. The Power Indicator Light will turn solid red and enter standby mode.

# Operating the Projector

## On-Screen Display (OSD) Menu

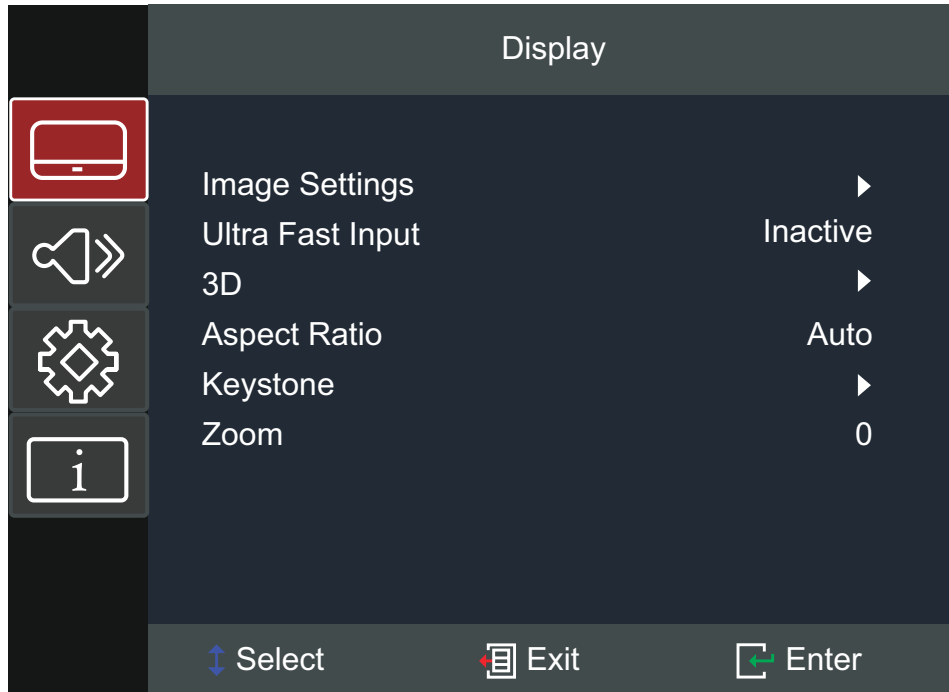
The projector has multilingual on-screen display menus that allow you to make image adjustments and change a variety of settings.

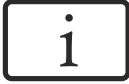

Menu		Description
Display		Adjust Image, Ultra Fast Input, 3D, Aspect Ratio, Zoom, and Keystone settings.
Audio		Adjust the volume level, audio mode, or mute.
Setup		Adjust Projection, Power, Security, Language, Input Source, etc. settings.
Information		View projector information.

## Menu Navigation

The projector has multilingual on-screen display menus that allow for image and settings adjustment.

1. To open the On-Screen Display (OSD) Menu, press the **Menu/Exit** button on the projector or the remote control.
2. When the OSD is displayed, use the **Navigation** buttons (**▲▼**) to select any item in the main menu. While making a selection on a particular page, press the **Enter** button on the projector or the remote control to enter a sub-menu.
3. Use the **Navigation** buttons (**◀▶**) to select the desired item in the sub-menu and then press **Enter** to view further settings. Adjust the settings by using the **Navigation** buttons (**◀▶**).
4. Select the next item to be adjusted in the sub-menu and adjust as described above.
5. Press **Enter** to confirm, and the screen will return to the main menu.
6. To exit, press the **Menu/Exit** button again. The OSD menu will close and the projector will automatically save the new settings.



## On-Screen Display (OSD) Menu Tree

Main Menu	Sub-menu	Menu Option			
Display	Image Settings	Display Mode	Standard		
			Bright		
			HDR		
			HLG		
			Cinema		
			Gaming		
			sRGB		
			User		
			3D		
		Brightness	(-/+, -50~50)		
		Contrast	(-/+, -50~50)		
		Sharpness	(-/+, 1~15)		
		Color	(-/+, -50~50)		
		Tint	(-/+, -50~50)		
		Gamma	Film		
			Video		
			Graphics		
			Standard (2.2)		
		Color Settings	BrilliantColor™	(-/+, 1~10)	
			Color Temperature	Warm	
				Standard	
				Cool	
				Cold	
Color Matching	Color				
	Red				
	Green				
	Blue				
	Cyan				
	Yellow				
	Magenta				
White					

Main Menu	Sub-menu	Menu Option			
Display	Image Settings	Color Settings	Color Matching	Hue / R (*)	(-/+ , -50~50)
				Saturation / G (*)	(-/+ , -50~50)
				Gain / B (*)	(-/+ , -50~50)
				Reset	
				Exit	
		Color Space	Auto		
			RGB (0~255)		
			RGB (16~235)		
			YUV		
		Brightness Mode	Dynamic Black	Eco	
				Power 100%~50%	
	Reset				
	Ultra Fast Input	Active			
		Inactive			
	3D	3D Mode	Off		
			On		
		3D Format	Auto		
			SBS		
			Top and Bottom		
			Frame Sequential		
		3D Sync Invert	Off		
On					
Aspect Ratio	4:3				
	16:9				
	Native				
	Auto				

Main Menu	Sub-menu	Menu Option	
Display	Keystone	Four Corners	Top-Left
			Top-Right
			Bottom-Left
			Bottom-Right
		H. Keystone	(-/+, -30~30)
		V. Keystone	(-/+, -30~30)
		3x3 Warp	
	Reset		
Zoom	(-/+, -5~25)		
Audio	Volume	(-/+, 0~10)	
	Mute	Off	
		On	
	Audio Mode	Bitstream	
		PCM	

Main Menu	Sub-menu	Menu Option		
Setup	Projection	Desk Front		
		Desk Rear		
		Ceiling Front		
		Ceiling Rear		
	Power Settings	Direct Power On	Off	
			On	
		Signal Power On	Off	
			On	
		Auto Power Off	(-/+ , 0~180) minutes	
	Security	Security	Off	
			On	
		Change Password		
	HDMI CEC	HDMI Link	Off	
			On	
		XBOX Mode	Off	
			On	
	Test Pattern	Test Pattern	Off	
			Green Grid	
			Magenta Grid	
			White Grid	
White				
Test Card				

Main Menu	Sub-menu	Menu Option	
Setup	Options	Language	English
			Deutsch
			Français
			Italiano
			Español
			Português
			Polski
			Nederlands
			Svenska
			Norsk
			Suomi
			ελληνικά
			繁體中文
			簡體中文
			日本語
			한국어
			Русский
			Čeština
			يبرع
			ไทย
			Türkçe
			Tiếng Việt
			Bahasa Indonesia
	High Altitude	Off	
		On	
	Auto Source	Off	
		On	
Keypad Lock	Off		
	On		
Logo	Default		
	Neutral		
Reset	Reset to Default		

Main Menu	Sub-menu	Menu Option	
<b>Information</b>	Serial Number		
	Source		
	Resolution		
	Refresh Rate		
	Light Source Hours		
	Display Mode		
	Brightness Mode		
	Firmware Version	System	
	MCU		

# Menu Operation

## Display Menu

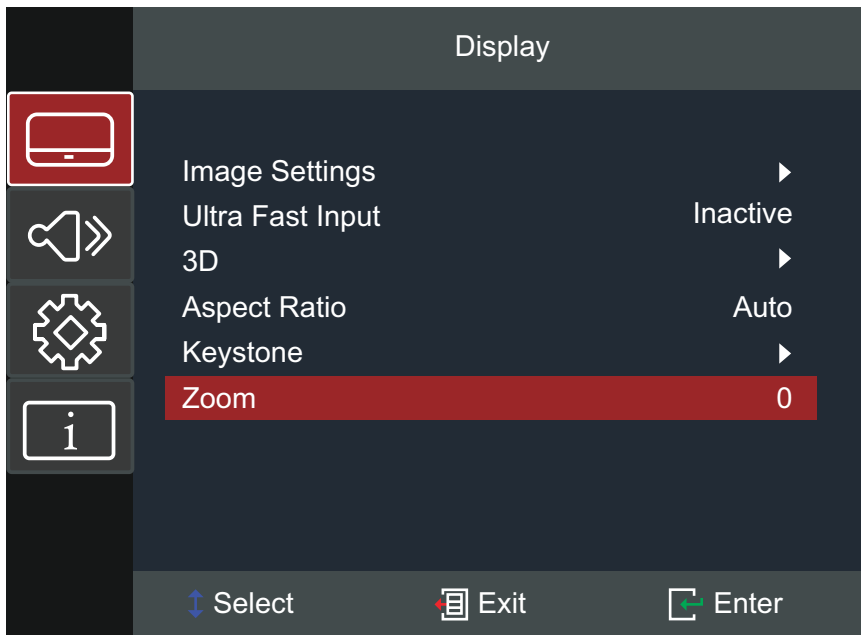

Menu	Description																				
<b>Image Settings</b>	<p><u>Display Mode</u></p> <p>There are several predefined display modes that you can choose from to suit your viewing preference.</p> <table border="1" style="width: 100%; border-collapse: collapse;"> <thead> <tr> <th style="background-color: #e91e63; color: white;">Mode</th> <th style="background-color: #e91e63; color: white;">Description</th> </tr> </thead> <tbody> <tr> <td style="text-align: center;"><b>Standard</b></td> <td>Designed for normal circumstances in a daylight environment.</td> </tr> <tr> <td style="text-align: center;"><b>Bright</b></td> <td>Suitable for bright, well-lit environments.</td> </tr> <tr> <td style="text-align: center;"><b>HDR</b></td> <td>Enable for HDR supported content and darker blacks, brighter highlights, and vivid color.</td> </tr> <tr> <td style="text-align: center;"><b>HLG</b></td> <td>Enable for HLG supported content and darker blacks, brighter highlights, and vivid color.</td> </tr> <tr> <td style="text-align: center;"><b>Cinema</b></td> <td>Provides the best balance of detail and colors for watching movies.</td> </tr> <tr> <td style="text-align: center;"><b>Gaming</b></td> <td>Optimizes your projector for maximum contrast and vivid colors allowing you to see shadow detail when playing games.</td> </tr> <tr> <td style="text-align: center;"><b>sRGB</b></td> <td>Standardized sRGB color gamut.</td> </tr> <tr> <td style="text-align: center;"><b>User</b></td> <td>User's custom settings.</td> </tr> <tr> <td style="text-align: center;"><b>3D</b></td> <td>Optimized for 3D content. <b>NOTE:</b> 3D glasses are needed.</td> </tr> </tbody> </table>	Mode	Description	<b>Standard</b>	Designed for normal circumstances in a daylight environment.	<b>Bright</b>	Suitable for bright, well-lit environments.	<b>HDR</b>	Enable for HDR supported content and darker blacks, brighter highlights, and vivid color.	<b>HLG</b>	Enable for HLG supported content and darker blacks, brighter highlights, and vivid color.	<b>Cinema</b>	Provides the best balance of detail and colors for watching movies.	<b>Gaming</b>	Optimizes your projector for maximum contrast and vivid colors allowing you to see shadow detail when playing games.	<b>sRGB</b>	Standardized sRGB color gamut.	<b>User</b>	User's custom settings.	<b>3D</b>	Optimized for 3D content. <b>NOTE:</b> 3D glasses are needed.
	Mode	Description																			
	<b>Standard</b>	Designed for normal circumstances in a daylight environment.																			
	<b>Bright</b>	Suitable for bright, well-lit environments.																			
	<b>HDR</b>	Enable for HDR supported content and darker blacks, brighter highlights, and vivid color.																			
	<b>HLG</b>	Enable for HLG supported content and darker blacks, brighter highlights, and vivid color.																			
	<b>Cinema</b>	Provides the best balance of detail and colors for watching movies.																			
	<b>Gaming</b>	Optimizes your projector for maximum contrast and vivid colors allowing you to see shadow detail when playing games.																			
	<b>sRGB</b>	Standardized sRGB color gamut.																			
	<b>User</b>	User's custom settings.																			
<b>3D</b>	Optimized for 3D content. <b>NOTE:</b> 3D glasses are needed.																				

Menu	Description
<p><b>Image Settings</b></p>	<p><u>Brightness</u> The higher the value, the brighter the image. Lower values will result in a darker image.</p> <p><u>Contrast</u> Use this to set the peak white level after you have previously adjusted the <b>Brightness</b> setting to suit your selected input and viewing environment.</p> <p><u>Sharpness</u> A high value results in a sharper picture; a low value softens the picture.</p> <p><u>Color</u> Adjust an image from black and white to fully saturated color.</p> <p><u>Tint</u> The higher the value, the more greenish the picture becomes. The lower the value, the more reddish the picture becomes.</p> <p><u>Gamma</u> Reflects the relationship between input source and picture brightness.</p>



Menu	Description																		
<b>Image Settings</b>	<p><u>Color Settings</u></p> <table border="1" data-bbox="609 230 1398 1290"> <thead> <tr> <th data-bbox="609 230 884 277">Setting</th> <th data-bbox="884 230 1398 277">Description</th> </tr> </thead> <tbody> <tr> <td data-bbox="609 277 884 439"><b>BrilliantColor™</b></td> <td data-bbox="884 277 1398 439">A color-processing algorithm and enhancements to enable higher brightness while providing true, more vibrant colors in picture.</td> </tr> <tr> <td data-bbox="609 439 884 521"><b>Color Temperature</b></td> <td data-bbox="884 439 1398 521">Select from Warm, Standard, Cool, or Cold.</td> </tr> <tr> <td data-bbox="609 521 884 1207"><b>Color Matching</b></td> <td data-bbox="884 521 1398 1207"> <p>Only in permanent installations with controlled lighting levels such as: boardrooms, lecture halls, or home theaters should Color Matching be considered.</p> <p>Color Matching provides fine color control adjustment to allow for more accurate color reproduction, should you require it.</p> <p>If you have purchased a test disc, which contains various color test patterns and can be used to test the color presentation on monitors, TVs, projectors, etc., you can project any image from the disc on the screen and enter the Color Matching menu to make adjustments.</p> </td> </tr> <tr> <td data-bbox="609 1207 884 1290"><b>Color Space</b></td> <td data-bbox="884 1207 1398 1290">Select from Auto, RGB (0~255), RGB (16~235), and YUV color space.</td> </tr> </tbody> </table> <p><u>Brightness Mode</u></p> <table border="1" data-bbox="609 1357 1398 1693"> <thead> <tr> <th data-bbox="609 1357 884 1404">Mode</th> <th data-bbox="884 1357 1398 1404">Description</th> </tr> </thead> <tbody> <tr> <td data-bbox="609 1404 884 1525"><b>Dynamic Black</b></td> <td data-bbox="884 1404 1398 1525">Automatically adjust the picture brightness in order to give optimum contrast performance.</td> </tr> <tr> <td data-bbox="609 1525 884 1608"><b>Eco</b></td> <td data-bbox="884 1525 1398 1608">Dim the light output, lowering power consumption.</td> </tr> <tr> <td data-bbox="609 1608 884 1693"><b>Power</b></td> <td data-bbox="884 1608 1398 1693">Select the power percentage (50%~100%) for brightness mode.</td> </tr> </tbody> </table> <p><u>Reset</u></p> <p>Return current display mode settings (Brightness, Contrast, Sharpness, Color, Tint, Gamma, Brilliant Color, Color Temperature, Color Matching, Color Space, Brightness Mode) to default values.</p>	Setting	Description	<b>BrilliantColor™</b>	A color-processing algorithm and enhancements to enable higher brightness while providing true, more vibrant colors in picture.	<b>Color Temperature</b>	Select from Warm, Standard, Cool, or Cold.	<b>Color Matching</b>	<p>Only in permanent installations with controlled lighting levels such as: boardrooms, lecture halls, or home theaters should Color Matching be considered.</p> <p>Color Matching provides fine color control adjustment to allow for more accurate color reproduction, should you require it.</p> <p>If you have purchased a test disc, which contains various color test patterns and can be used to test the color presentation on monitors, TVs, projectors, etc., you can project any image from the disc on the screen and enter the Color Matching menu to make adjustments.</p>	<b>Color Space</b>	Select from Auto, RGB (0~255), RGB (16~235), and YUV color space.	Mode	Description	<b>Dynamic Black</b>	Automatically adjust the picture brightness in order to give optimum contrast performance.	<b>Eco</b>	Dim the light output, lowering power consumption.	<b>Power</b>	Select the power percentage (50%~100%) for brightness mode.
	Setting	Description																	
	<b>BrilliantColor™</b>	A color-processing algorithm and enhancements to enable higher brightness while providing true, more vibrant colors in picture.																	
	<b>Color Temperature</b>	Select from Warm, Standard, Cool, or Cold.																	
	<b>Color Matching</b>	<p>Only in permanent installations with controlled lighting levels such as: boardrooms, lecture halls, or home theaters should Color Matching be considered.</p> <p>Color Matching provides fine color control adjustment to allow for more accurate color reproduction, should you require it.</p> <p>If you have purchased a test disc, which contains various color test patterns and can be used to test the color presentation on monitors, TVs, projectors, etc., you can project any image from the disc on the screen and enter the Color Matching menu to make adjustments.</p>																	
	<b>Color Space</b>	Select from Auto, RGB (0~255), RGB (16~235), and YUV color space.																	
	Mode	Description																	
	<b>Dynamic Black</b>	Automatically adjust the picture brightness in order to give optimum contrast performance.																	
	<b>Eco</b>	Dim the light output, lowering power consumption.																	
	<b>Power</b>	Select the power percentage (50%~100%) for brightness mode.																	

Menu	Description										
<b>Ultra Fast Input</b>	<p>This function is favorable to frame rate reducing. Quick response time in native timing can be achieved. When enabled, the following settings (if applicable) will return to factory preset values and disabled: Warping, Keystone, Four corners., Aspect Ratio, Zoom.</p> <p><b>NOTE:</b> This function is only available when a 4K@60Hz, 1440P@60/120Hz and 1080P@60/120/240Hz input signal is selected. If you want to adjust Warping, Keystone, Four corners, Aspect Ratio, or Zoom, please disable Ultra Fast input.</p>										
<b>3D</b>	<p><u>3D Mode</u> Enable or disable the 3D function.</p> <p><u>3D Format</u> Select the 3D content format.</p> <p><b>NOTE:</b> A Blu-ray 3D source will be detected automatically, and options will not be selectable.</p> <table border="1" style="margin-left: auto; margin-right: auto;"> <thead> <tr> <th style="background-color: #ff0000; color: white;">Option</th> <th style="background-color: #ff0000; color: white;">Description</th> </tr> </thead> <tbody> <tr> <td style="text-align: center;"><b>Auto</b></td> <td>When a 3D identification signal is detected, the 3D format is selected automatically.</td> </tr> <tr> <td style="text-align: center;"><b>SBS</b></td> <td>Display in Side-by-Side format.</td> </tr> <tr> <td style="text-align: center;"><b>Top and Bottom</b></td> <td>Display in Top and Bottom format.</td> </tr> <tr> <td style="text-align: center;"><b>Frame Sequential</b></td> <td>Display in Frame Sequential format.</td> </tr> </tbody> </table> <p><u>3D Sync Invert</u> Enable or disable the 3D Sync Invert function.</p>	Option	Description	<b>Auto</b>	When a 3D identification signal is detected, the 3D format is selected automatically.	<b>SBS</b>	Display in Side-by-Side format.	<b>Top and Bottom</b>	Display in Top and Bottom format.	<b>Frame Sequential</b>	Display in Frame Sequential format.
Option	Description										
<b>Auto</b>	When a 3D identification signal is detected, the 3D format is selected automatically.										
<b>SBS</b>	Display in Side-by-Side format.										
<b>Top and Bottom</b>	Display in Top and Bottom format.										
<b>Frame Sequential</b>	Display in Frame Sequential format.										

**NOTE:** This projector is a 3D ready projector with DLP-Link 3D solution. Please make sure your 3D glasses are for DLP-Link 3D. This projector supports frame sequential (page-flip) 3D via the **HDMI 1/HDMI 2** ports. For the best performance, 1920 x 1080 resolution is recommended. Please note that 4K (3840 x 2160) resolution is not supported in 3D mode.

Menu	Description										
<p style="text-align: center;"><b>Aspect Ratio</b></p>	<p>Select the aspect ratio of the projected image.</p> <table border="1" data-bbox="609 226 1396 1294"> <thead> <tr> <th data-bbox="609 226 884 275">Aspect Ratio</th> <th data-bbox="884 226 1396 275">Description</th> </tr> </thead> <tbody> <tr> <td data-bbox="609 275 884 546" style="text-align: center;"><b>4:3</b></td> <td data-bbox="884 275 1396 546">Scales an image so that it is displayed in the center of the screen with a 4:3 aspect ratio. This is most suitable for 4:3 images like computer monitors, standard definition TV, and 4:3 aspect DVD movies, as it displays them without aspect alteration.</td> </tr> <tr> <td data-bbox="609 546 884 784" style="text-align: center;"><b>16:9</b></td> <td data-bbox="884 546 1396 784">Scales an image so that it is displayed in the center of the screen with a 16:9 aspect ratio. This is most suitable for images which are already in a 16:9 aspect, like high definition TV.</td> </tr> <tr> <td data-bbox="609 784 884 1021" style="text-align: center;"><b>Native</b></td> <td data-bbox="884 784 1396 1021">Projects the image as its original resolution and resizes it to fit within the display area. For input signals with lower resolutions, the projected image will be displayed in its original size.</td> </tr> <tr> <td data-bbox="609 1021 884 1294" style="text-align: center;"><b>Auto</b></td> <td data-bbox="884 1021 1396 1294">Scales an image proportionally to fit the projector's native resolution in its horizontal width. This is suitable for the incoming image which is neither 4:3 nor 16:9 and you want to make the most use of the screen without altering the image's aspect ratio.</td> </tr> </tbody> </table>	Aspect Ratio	Description	<b>4:3</b>	Scales an image so that it is displayed in the center of the screen with a 4:3 aspect ratio. This is most suitable for 4:3 images like computer monitors, standard definition TV, and 4:3 aspect DVD movies, as it displays them without aspect alteration.	<b>16:9</b>	Scales an image so that it is displayed in the center of the screen with a 16:9 aspect ratio. This is most suitable for images which are already in a 16:9 aspect, like high definition TV.	<b>Native</b>	Projects the image as its original resolution and resizes it to fit within the display area. For input signals with lower resolutions, the projected image will be displayed in its original size.	<b>Auto</b>	Scales an image proportionally to fit the projector's native resolution in its horizontal width. This is suitable for the incoming image which is neither 4:3 nor 16:9 and you want to make the most use of the screen without altering the image's aspect ratio.
	Aspect Ratio	Description									
	<b>4:3</b>	Scales an image so that it is displayed in the center of the screen with a 4:3 aspect ratio. This is most suitable for 4:3 images like computer monitors, standard definition TV, and 4:3 aspect DVD movies, as it displays them without aspect alteration.									
	<b>16:9</b>	Scales an image so that it is displayed in the center of the screen with a 16:9 aspect ratio. This is most suitable for images which are already in a 16:9 aspect, like high definition TV.									
	<b>Native</b>	Projects the image as its original resolution and resizes it to fit within the display area. For input signals with lower resolutions, the projected image will be displayed in its original size.									
<b>Auto</b>	Scales an image proportionally to fit the projector's native resolution in its horizontal width. This is suitable for the incoming image which is neither 4:3 nor 16:9 and you want to make the most use of the screen without altering the image's aspect ratio.										
<b>Zoom</b>	Reduce or magnify the projected image.										

Menu	Description	
<b>Keystone</b>	<b>Option</b>	<b>Description</b>
	<b>Four Corners</b>	Adjust each corner to make a square image when the projection surface is not level.  <b>NOTE:</b> While adjusting the Four Corners, the Aspect Ratio, and Zoom menus will be disabled. To enable them, reset the Keystone settings to default.
	<b>H. Keystone</b>	Adjust image distortion horizontally.
	<b>V. Keystone</b>	Adjust image distortion vertically.
	<b>3x3 Warp</b>	Configure the geometric distortion of the projector's images when the images are projected onto screens which have an uneven surface such as a cylinder, a spherical shape, etc.
<b>Reset</b>	Return the Keystone settings to default.	

## Audio Menu

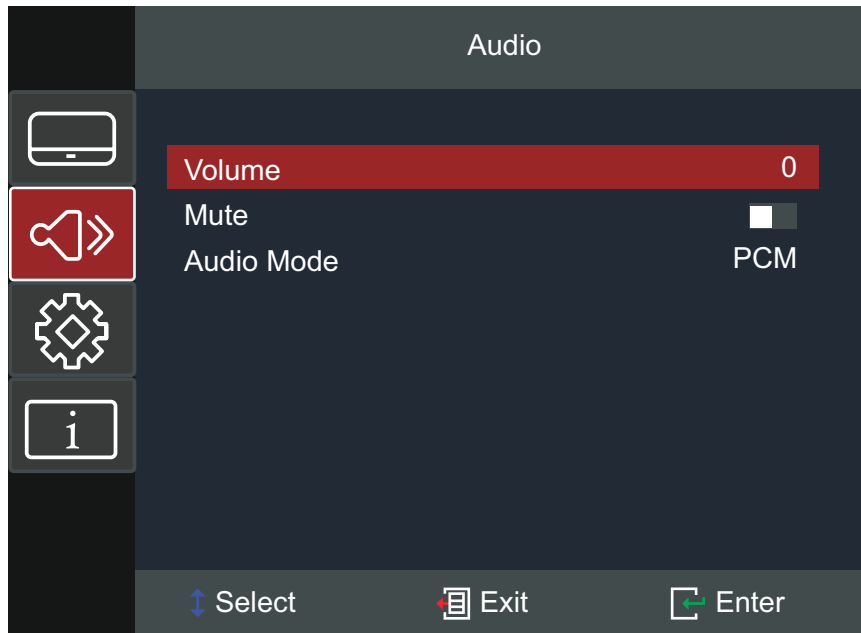

Menu	Description						
<b>Volume</b>	Adjust the volume level.						
<b>Mute</b>	Temporarily turn off the sound.						
<b>Audio Mode</b>	Select the preferred audio mode.						
	<table border="1"> <thead> <tr> <th>Option</th> <th>Description</th> </tr> </thead> <tbody> <tr> <td><b>Bitstream</b></td> <td>Play sound via the projector's speakers.</td> </tr> <tr> <td><b>PCM</b></td> <td>Switch to ARC/eARC.</td> </tr> </tbody> </table>	Option	Description	<b>Bitstream</b>	Play sound via the projector's speakers.	<b>PCM</b>	Switch to ARC/eARC.
	Option	Description					
<b>Bitstream</b>	Play sound via the projector's speakers.						
<b>PCM</b>	Switch to ARC/eARC.						

## Setup Menu

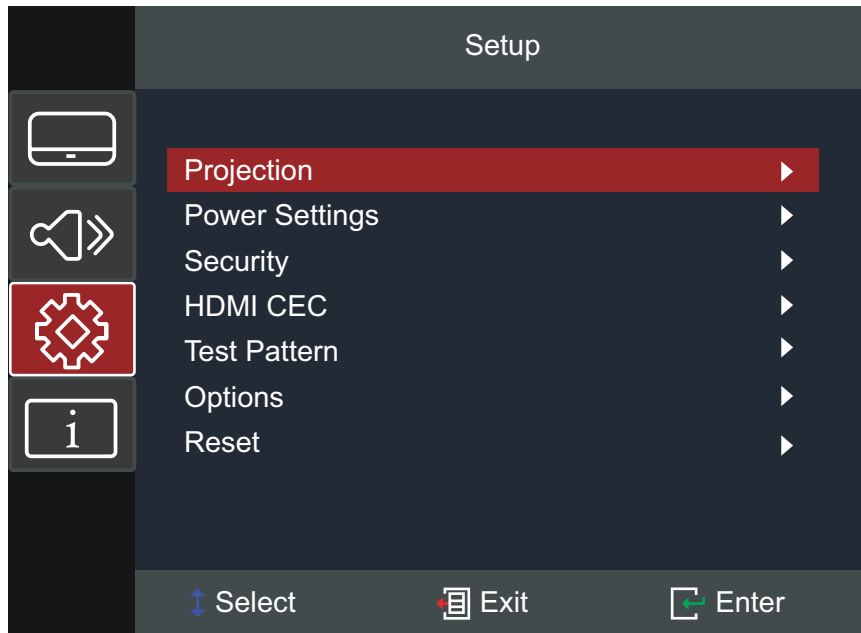

Menu	Description
<b>Projection</b>	Select the preferred projection location: Desk Front, Desk Rear, Ceiling Front, or Ceiling Rear.
<b>Power Settings</b>	<p><u>Direct Power On</u> Automatically power on the projector when DC power is supplied, without pressing the <b>Power</b> button on the projector or the remote control.</p> <p><u>Signal Power On</u> Automatically power on the projector when a signal is detected, without pressing the <b>Power</b> button on the projector or on the remote control.</p> <p><u>Auto Power Off</u> A countdown timer will start when there is no signal being sent to the projector. The projector will automatically power off when the countdown has finished (in minutes).</p>
<b>Security</b>	<p><u>Security</u> Enable or disable a password prompt before using the projector. <b>NOTE:</b> The default password is: 1234</p> <p><u>Change Password</u> Set or modify the password. <b>NOTE:</b> Please follow the OSD message to input the current password first, then enter a new password (security code). Confirm the new password by entering the new password again.</p>

Menu	Description
<p style="text-align: center;"><b>HDMI CEC</b></p>	<p><u>HDMI Link</u> When you connect HDMI CEC-compatible devices to the projector with HDMI cables, you can control them on the same power on or power off status using the HDMI CEC control feature in the projector's OSD. This lets one device or multiple devices in a group power on or power off via HDMI CEC in a typical configuration.</p> <p><b>NOTE:</b></p> <ul style="list-style-type: none"> <li>• In order for the CEC function to work properly, make sure that the device is correctly connected to the <b>HDMI</b> input of the projector via an HDMI cable, and its CEC function is turned on.</li> <li>• If both <b>HDMI 1</b> and <b>HDMI 2</b> ports are occupied, the CEC function will not be able to detect the correct source.</li> <li>• Depending on the connected device, the CEC function may not work.</li> </ul> <p><u>XBOX Mode</u> Enable/disable XBOX CEC function.</p> <p><b>NOTE:</b> This option will show up when enabling HDMI Link. Please connect XBOX via the <b>HDMI 1</b> port.</p>
<p style="text-align: center;"><b>Test Pattern</b></p>	<p>Select the test pattern from green grid, magenta grid, white grid, white, test card or disable this function (off).</p>

Menu	Description						
<b>Options</b>	<p><u>Language</u> Select the On-Screen Display (OSD) Menu language.</p> <p><u>High Altitude</u> When On, the fans will spin faster for better cooling and performance. This is useful for high altitude environments where the air is thin.</p> <p><u>Auto Source</u> Automatically find an available input source.</p> <table border="1" data-bbox="609 544 1398 956"> <thead> <tr> <th data-bbox="609 544 884 591">Option</th> <th data-bbox="884 544 1398 591">Description</th> </tr> </thead> <tbody> <tr> <td data-bbox="609 591 884 712" style="text-align: center;"><b>Off</b></td> <td data-bbox="884 591 1398 712">Only search the current input selection. Press the <b>Source</b> button to display the list of sources.</td> </tr> <tr> <td data-bbox="609 712 884 956" style="text-align: center;"><b>On</b></td> <td data-bbox="884 712 1398 956">Automatically finds an available input source. Press the <b>Source</b> button to automatically detect the next source.  <b>NOTE:</b> The scan order is: <b>HDMI 1 &gt; HDMI 2.</b></td> </tr> </tbody> </table> <p><u>Keypad Lock</u> Lock all keypad buttons, except for the <b>Power</b> key. <b>NOTE:</b> To release keypad lock, press and hold the <b>Enter</b> key on the projector for 5 seconds. You can also use the remote control and go to: <b>Setup &gt; Options &gt; Keypad Lock &gt; Off.</b></p> <p><u>Logo</u> Set the “startup screen”. If changes are made, they will take effect the next time the projector is powered on. <b>NOTE:</b> <b>Neutral</b> is a black screen.</p>	Option	Description	<b>Off</b>	Only search the current input selection. Press the <b>Source</b> button to display the list of sources.	<b>On</b>	Automatically finds an available input source. Press the <b>Source</b> button to automatically detect the next source.  <b>NOTE:</b> The scan order is: <b>HDMI 1 &gt; HDMI 2.</b>
Option	Description						
<b>Off</b>	Only search the current input selection. Press the <b>Source</b> button to display the list of sources.						
<b>On</b>	Automatically finds an available input source. Press the <b>Source</b> button to automatically detect the next source.  <b>NOTE:</b> The scan order is: <b>HDMI 1 &gt; HDMI 2.</b>						
<b>Reset</b>	<p>Return the settings to default. <b>NOTE:</b> When resetting, the following settings will still remain: Language, Projection, High Altitude, Security Settings, Zoom, Keystone Settings, and Light Source Hours.</p>						



## Information Menu

View Serial Number, Source, Resolution, Refresh Rate, Display Mode, Light Source Hours, Brightness Mode, and Firmware Version information.

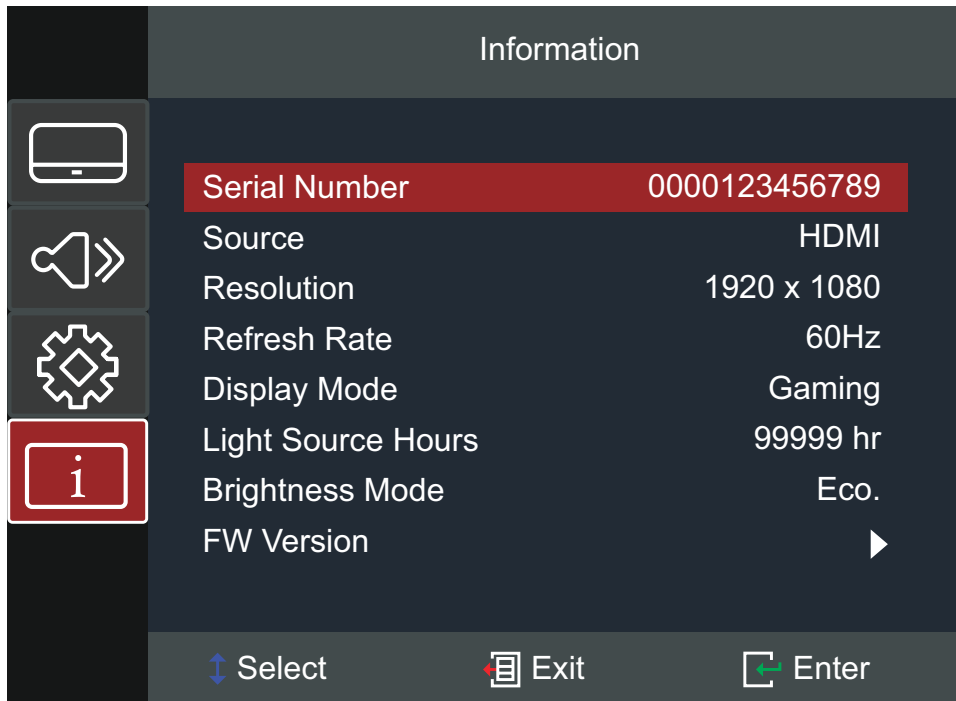

# Appendix

## Specifications

Item	Category	Specifications
Projector	Type	Laser
	Display Size	30"~300"
	Throw Ratio	1.06~1.45 (100"@2.34 m)
	Lens	F=2.51~2.93, f=15.985~21.423 mm
	Display System	1-CHIP DMD
Input Signal	HDMI (v. 2.0)	$f_h$ : 15~255 kHz, $f_v$ : 24~240 Hz, Pixel rate: 600 MHz
Resolution	Native	3840 x 2160
Power	Input Voltage	DC 100~240V, 50/60 Hz (auto switch)
Operating Conditions	Temperature	0°C to 40°C (32°F to 104°F)
	Humidity	10% to 80% (non-condensing)
	Altitude	0 to 760 m (0 to 2,500 ft.) at 0°C to 40°C (32°F to 104°F) 760 to 1,520 m (2,500 to 5,000 ft.) at 0°C to 35°C (32°F to 95°F) 1,520 to 3,048 m (5,000 to 10,000 ft.) at 0°C to 30°C (32°F to 86°F)
Storage Conditions	Temperature	-20°C to 60°C (-4°F to 140°F)
	Humidity	5% to 90% (non-condensing)
	Altitude	0 to 12,100 m (0 to 40,000 ft.)
Dimensions	Physical (W x H x D)	286 x 129 x 216 mm (11.26" x 5.08" x 8.50")
Weight	Physical	3.30 kg (7.26 lbs)
Power Consumption	On <sup>1</sup>	180W (Typical)
	Off	< 0.5W (Standby)

<sup>1</sup> The test condition follows EEI standards.

# Projector Dimensions

286 mm (W) x 129 mm (H) x 216 mm (D)

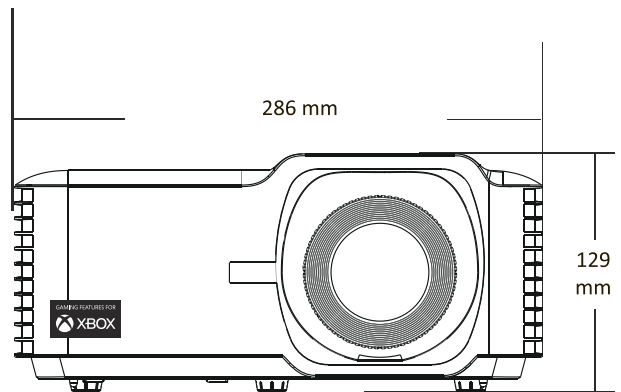
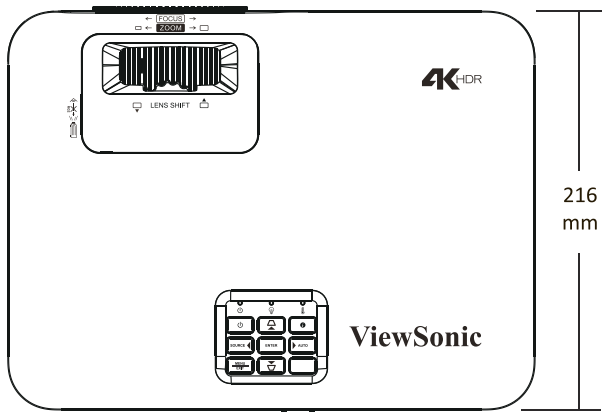

# Timing Chart

## HDMI Video Timing

Timing	Resolution	Refresh Rate (Hz)
SDTV(480i)	720 x 480	60
SDTV(480p)	720 x 480	60
SDTV(576i)	720 x 576	50
SDTV(576p)	720 x 576	50
HDTV(720p)	1280 x 720	50/60
HDTV(1080i)	1920 x 1080	50/60
HDTV(1080p)	1920 x 1080	24 / 25 / 30 / 50 / 60 / 120
4K	3840 x 2160	24 / 25 / 30 / 50 / 60

## HDMI PC Timing

Timing	Resolution	Refresh Rate (Hz)
VGA	640 x 480	60 / 67 / 72 / 75
	720 x 400	70
SVGA	800 x 600	56 / 60 / 72 / 75
	832 x 624	75
XGA	1024 x 768	60 / 70 / 75
	1152 x 864	70 / 75 / 85
SXGA	1280 x 1024	75
PowerBook G4	1152 x 870	75

## HDMI Extended Wide Timing

Timing	Resolution	Refresh Rate (Hz)
XGA	1152 x 864	75
SXGA	1280 x 1024	60
Quad VGA	1280 x 960	60
WXGA	1280 x 720	120
	1440 x 900	60
WSXGA+	1680 x 1050	60
	1920 x 1080	60 / 240
WUXGA	1920 x 1200-RB	60
2K	2560 x 1440	120

### 3D Support Timing

<b>HDMI 3D</b>		
<b>Frame Packing Format</b>		
<b>Timing</b>	<b>Resolution</b>	<b>Refresh Rate (Hz)</b>
<b>720p</b>	1280 x 720	50 / 60
<b>1080p</b>	1920 x 1080	24
<b>Side by Side Format</b>		
<b>Timing</b>	<b>Resolution</b>	<b>Refresh Rate (Hz)</b>
<b>1080i</b>	1920 x 1080	50 / 60
<b>Top and Bottom Format</b>		
<b>Timing</b>	<b>Resolution</b>	<b>Refresh Rate (Hz)</b>
<b>720p</b>	1280 x 720	50 / 60
<b>1080p</b>	1920 x 1080	24
<b>HQFS</b>		
<b>SVGA</b>	800 x 600	120
<b>XGA</b>	1024 x 768	120
<b>WXGA</b>	1280 x 800	120

**NOTE:**

- 1080i @ 25 Hz and 720p @ 50Hz will run in 100 Hz;Other 3D timing will run in 120 Hz.
- 1080p @ 24 Hz will run 144 Hz (XGA, WXGA, 1080p)/96 Hz(WUXGA).
- If the input frame rate is 48 Hz or greater,the output frame rate is set to twice the input frame rate(FRC=2X mode).
- If the 3D input frame rate is 25 Hz or greater,the output frame rate is set to four times the input frame rate(FRC=4X mode).
- If the 3D input frame rate is 24 Hz(including 23.94 Hz),the output frame rate is set to six times the input frame rate(FRC=6X mode).

## Troubleshooting

This section describes some common problems that you may experience when using the projector.

Problem or Issue	Possible Solutions
The projector does not turn on	<ul style="list-style-type: none"><li>• Ensure the power cord is properly attached to the projector and to the power outlet.</li><li>• If the cooling process has not completed, please wait until it has finished then try to turn on the projector again.</li><li>• If the above does not work, try another power outlet or another electrical device with the same power outlet.</li></ul>
There is no picture	<ul style="list-style-type: none"><li>• Ensure the video source cable is connected properly, and that the video source is turned on.</li><li>• If the input source is not selected automatically, select the correct source with the “Source Input” on either the projector or the remote control.</li></ul>
The image is blurred	<ul style="list-style-type: none"><li>• Adjusting focus with the <b>Focus Ring</b> will help correctly focus the projection lens.</li><li>• Ensure the projector and screen are aligned properly. If necessary, adjust the height of the projector as well as the projection angle and direction.</li></ul>
The image is reversed	<ul style="list-style-type: none"><li>• Open the OSD Menu and go to: <b>Setup &gt; Projection</b> and adjust the projection option.</li></ul>
The image is stretched when projecting a 16:9 DVD	<ul style="list-style-type: none"><li>• When you play an anamorphic DVD or 16:9 DVD, the projector will show the best image in 16:9.</li><li>• If you play a 4:3 format DVD title, please change the format as 4:3 in projector OSD Menu.</li><li>• Please setup the display format as 16:9 (wide) aspect ratio on the DVD player.</li></ul>

Problem or Issue	Possible Solutions
The remote control does not work	<ul style="list-style-type: none"> <li>• Ensure there are no obstacles between the remote control and projector; and that they are within range, 8m (26 ft).</li> <li>• The batteries may be out of power, please check and replace if necessary.</li> </ul>
The projector stops responding to all controls	<ul style="list-style-type: none"> <li>• Turn off the projector and unplug the power cord. Wait at least 20 seconds then reconnect and try again.</li> </ul>

## LED Indicators

When the warning indicators (see below) light up or flash, the projector will automatically shutdown. Unplug the power cord from the projector, wait for 30 seconds and try again. If the warning indicators light up or flash, please contact your nearest service center for assistance.

Status and Description	Power Indicator Light		Temperature Indicator Light	Light Source Indicator Light
	Red	Blue	Red	Red
<b>Standby State (Power cord input)</b>	Steady Light			
<b>Power On (Warming)</b>		Flashing Light (0.5 sec. off/0.5 sec. light)		
<b>Power On and Lamp Lighting</b>		Steady Light		
<b>Power Off (Cooling)</b>		Flashing Light (0.5 sec. off/0.5 sec. light); back to steady red light when cooling fans turn off		
<b>Error (Lamp failure)</b>	Flashing Light			Steady Light
<b>Error (Fan failure)</b>	Flashing Light		Flashing Light	
<b>Error (Overheating)</b>	Flashing Light		Steady Light	



# Maintenance

## General Precautions

- Make sure the projector is turned off and the power cable is unplugged from the power outlet.
- Never remove any parts from the projector. Contact ViewSonic® or a reseller when any part of the projector needs replacing.
- Never spray or pour any liquid directly onto the case.
- Handle the projector with care, as a darker-colored projector, if scuffed, may show marks more clearly than a lighter-colored projector.

## Cleaning the Lens

- Use a canister of compressed air to remove dust.
- If the lens is still not clean, use lens-cleaning paper or moisten a soft cloth with lens cleaner and gently wipe the surface.

**CAUTION:** Never rub the lens with abrasive materials.

## Cleaning the Case

- Use a soft, lint-free, dry cloth to remove dirt or dust.
- If the case is still not clean, apply a small amount of non-ammonia, non-alcohol based, mild non-abrasive detergent onto a clean, soft, lint-free cloth, then wipe the surface.

**CAUTION:** Never use wax, alcohol, benzene, thinner, or other chemical detergents.

## Storing the Projector

If you intend to store the projector for an extended period of time:

- Ensure the temperature and humidity of the storage area are within the recommend range.
- Retract the adjuster foot completely.
- Remove the batteries from the remote control.
- Pack the projector in its original packaging or equivalent.

## Disclaimer

- ViewSonic® does not recommend the use of any ammonia or alcohol-based cleaners on the lens or case. Some chemical cleaners have been reported to damage the lens and/or case of the projector.
- ViewSonic® will not be liable for damage resulting from use of any ammonia or alcohol-based cleaners.

# Regulatory and Service Information

## Compliance Information

This section addresses all connected requirements and statements regarding regulations. Confirmed corresponding applications shall refer to nameplate labels and relevant markings on the unit.

### FCC Compliance Statement

This device complies with part 15 of FCC Rules. Operation is subject to the following two conditions: (1) this device may not cause harmful interference, and (2) this device must accept any interference received, including interference that may cause undesired operation. This equipment has been tested and found to comply with the limits for a Class B digital device, pursuant to part 15 of the FCC Rules.

These limits are designed to provide reasonable protection against harmful interference in a residential installation. This equipment generates, uses, and can radiate radio frequency energy, and if not installed and used in accordance with the instructions, may cause harmful interference to radio communications. However, there is no guarantee that interference will not occur in a particular installation. If this equipment does cause harmful interference to radio or television reception, which can be determined by turning the equipment off and on, the user is encouraged to try to correct the interference by one or more of the following measures:

- Reorient or relocate the receiving antenna.
- Increase the separation between the equipment and receiver.
- Connect the equipment into an outlet on a circuit different from that to which the receiver is connected.
- Consult the dealer or an experienced radio/TV technician for help.

**Warning:** You are cautioned that changes or modifications not expressly approved by the party responsible for compliance could void your authority to operate the equipment.

### Industry Canada Statement

This Class B digital apparatus complies with Canadian ICES-003.

Cet appareil numérique de classe B est conforme à la norme NMB-003 du Canada.

CAN ICES-003(B) / NMB-003(B)

## CE Conformity for European Countries

**CE** The device complies with the EMC Directive 2014/30/EU and Low Voltage Directive 2014/35/EU. Ecodesign Directive 2009/125/EC.

### The following information is only for EU-member states:

The mark shown to the right is in compliance with the Waste Electrical and Electronic Equipment Directive 2012/19/EU (WEEE). The mark indicates the requirement NOT to dispose of the equipment as unsorted municipal waste, but use the return and collection systems according to local law.

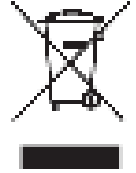

## Declaration of RoHS2 Compliance

This product has been designed and manufactured in compliance with Directive 2011/65/EU of the European Parliament and the Council on restriction of the use of certain hazardous substances in electrical and electronic equipment (RoHS2 Directive) and is deemed to comply with the maximum concentration values issued by the European Technical Adaptation Committee (TAC) as shown below:

Substance	Proposed Maximum Concentration	Actual Concentration
Lead (Pb)	0.1%	< 0.1%
Mercury (Hg)	0.1%	< 0.1%
Cadmium (Cd)	0.01%	< 0.01%
Hexavalent Chromium (Cr6 <sup>+</sup> )	0.1%	< 0.1%
Polybrominated biphenyls (PBB)	0.1%	< 0.1%
Polybrominated diphenyl ethers (PBDE)	0.1%	< 0.1%
Bis (2-ethylhexyl) phthalate (DEHP)	0.1%	< 0.1%
Butyl benzyl phthalate (BBP)	0.1%	< 0.1%
Dibutyl phthalate (DBP)	0.1%	< 0.1%
Diisobutyl phthalate (DIBP)	0.1%	< 0.1%

**Certain components of products as stated above are exempted under the Annex III of the RoHS2 Directives as noted below. Examples of exempted components are:**

- Mercury in cold cathode fluorescent lamps and external electrode fluorescent lamps (CCFL and EEFL) for special purposes not exceeding (per lamp):
  - » Short length (500 mm): maximum 3.5 mg per lamp.
  - » Medium length (> 500 mm and 1,500 mm): maximum 5 mg per lamp.
  - » Long length (> 1,500 mm): maximum 13 mg per lamp.
- Lead in glass of cathode ray tubes.
- Lead in glass of fluorescent tubes not exceeding 0.2% by weight.
- Lead as an alloying element in aluminum containing up to 0.4% lead by weight.
- Copper alloy containing up to 4% lead by weight.
- Lead in high melting temperature type solders (i.e. lead-based alloys containing 85% by weight or more lead).
- Electrical and electronic components containing lead in a glass or ceramic other than dielectric ceramic in capacitors, e.g. piezoelectronic devices, or in a glass or ceramic matrix compound.

## **Indian Restriction of Hazardous Substances**

Restriction on Hazardous Substances statement (India). This product complies with the “India E-waste Rule 2011” and prohibits use of lead, mercury, hexavalent chromium, polybrominated biphenyls or polybrominated diphenyl ethers in concentrations exceeding 0.1 weight % and 0.01 weight % for cadmium, except for the exemptions set in Schedule 2 of the Rule.

## **Product Disposal at End of Product Life**

ViewSonic® respects the environment and is committed to working and living green. Thank you for being part of Smarter, Greener Computing. Please visit the ViewSonic® website to learn more.

### **USA & Canada:**

<https://www.viewsonic.com/us/go-green-with-viewsonic>

### **Europe:**

<https://www.viewsonic.com/eu/go-green-with-viewsonic>

### **Taiwan:**

<https://recycle.epa.gov.tw/>

## Copyright Information

Copyright© ViewSonic® Corporation, 2024. All rights reserved.

Macintosh and Power Macintosh are registered trademarks of Apple Inc.

Microsoft, Windows, and the Windows logo are registered trademarks of Microsoft Corporation in the United States and other countries.

ViewSonic®, the three birds logo are registered trademarks of ViewSonic® Corporation.

VESA is a registered trademark of the Video Electronics Standards Association. DPMS, DisplayPort, and DDC are trademarks of VESA.

ENERGY STAR® is a registered trademark of the U.S. Environmental Protection Agency (EPA).

As an ENERGY STAR® partner, ViewSonic® Corporation has determined that this product meets the ENERGY STAR® guidelines for energy efficiency.

**Disclaimer:** ViewSonic® Corporation shall not be liable for technical or editorial errors or omissions contained herein; nor for incidental or consequential damages resulting from furnishing this material, or the performance or use of this product.

In the interest of continuing product improvement, ViewSonic® Corporation reserves the right to change product specifications without notice. Information in this document may change without notice.

No part of this document may be copied, reproduced, or transmitted by any means, for any purpose without prior written permission from ViewSonic® Corporation.

## Customer Service

For technical support or product service, see the table below or contact your reseller.

**NOTE:** You will need the product's serial number.

Country/ Region	Website	Country/ Region	Website
<b>Asia Pacific &amp; Africa</b>			
Australia	<a href="http://www.viewsonic.com/au/">www.viewsonic.com/au/</a>	Bangladesh	<a href="http://www.viewsonic.com/bd/">www.viewsonic.com/bd/</a>
中国 (China)	<a href="http://www.viewsonic.com.cn">www.viewsonic.com.cn</a>	香港 (繁體中文)	<a href="http://www.viewsonic.com/hk/">www.viewsonic.com/hk/</a>
Hong Kong (English)	<a href="http://www.viewsonic.com/hk-en/">www.viewsonic.com/hk-en/</a>	India	<a href="http://www.viewsonic.com/in/">www.viewsonic.com/in/</a>
Indonesia	<a href="http://www.viewsonic.com/id/">www.viewsonic.com/id/</a>	Israel	<a href="http://www.viewsonic.com/il/">www.viewsonic.com/il/</a>
日本 (Japan)	<a href="http://www.viewsonic.com/jp/">www.viewsonic.com/jp/</a>	Korea	<a href="http://www.viewsonic.com/kr/">www.viewsonic.com/kr/</a>
Malaysia	<a href="http://www.viewsonic.com/my/">www.viewsonic.com/my/</a>	Middle East	<a href="http://www.viewsonic.com/me/">www.viewsonic.com/me/</a>
Myanmar	<a href="http://www.viewsonic.com/mm/">www.viewsonic.com/mm/</a>	Nepal	<a href="http://www.viewsonic.com/np/">www.viewsonic.com/np/</a>
New Zealand	<a href="http://www.viewsonic.com/nz/">www.viewsonic.com/nz/</a>	Pakistan	<a href="http://www.viewsonic.com/pk/">www.viewsonic.com/pk/</a>
Philippines	<a href="http://www.viewsonic.com/ph/">www.viewsonic.com/ph/</a>	Singapore	<a href="http://www.viewsonic.com/sg/">www.viewsonic.com/sg/</a>
臺灣 (Taiwan)	<a href="http://www.viewsonic.com/tw/">www.viewsonic.com/tw/</a>	ประเทศไทย	<a href="http://www.viewsonic.com/th/">www.viewsonic.com/th/</a>
Việt Nam	<a href="http://www.viewsonic.com/vn/">www.viewsonic.com/vn/</a>	South Africa & Mauritius	<a href="http://www.viewsonic.com/za/">www.viewsonic.com/za/</a>
<b>Americas</b>			
United States	<a href="http://www.viewsonic.com/us">www.viewsonic.com/us</a>	Canada	<a href="http://www.viewsonic.com/us">www.viewsonic.com/us</a>
Latin America	<a href="http://www.viewsonic.com/la">www.viewsonic.com/la</a>		
<b>Europe</b>			
Europe	<a href="http://www.viewsonic.com/eu/">www.viewsonic.com/eu/</a>	France	<a href="http://www.viewsonic.com/fr/">www.viewsonic.com/fr/</a>
Deutschland	<a href="http://www.viewsonic.com/de/">www.viewsonic.com/de/</a>	Қазақстан	<a href="http://www.viewsonic.com/kz/">www.viewsonic.com/kz/</a>
Россия	<a href="http://www.viewsonic.com/ru/">www.viewsonic.com/ru/</a>	España	<a href="http://www.viewsonic.com/es/">www.viewsonic.com/es/</a>
Türkiye	<a href="http://www.viewsonic.com/tr/">www.viewsonic.com/tr/</a>	Україна	<a href="http://www.viewsonic.com/ua/">www.viewsonic.com/ua/</a>
United Kingdom	<a href="http://www.viewsonic.com/uk/">www.viewsonic.com/uk/</a>		

## **Limited Warranty**

### ViewSonic® Projector

#### **What the warranty covers:**

ViewSonic® warrants its products to be free from defects in material and workmanship, under normal use, during the warranty period. If a product proves to be defective in material or workmanship during the warranty period, ViewSonic® will, at its sole option, repair or replace the product with a like product. Replacement product or parts may include remanufactured or refurbished parts or components.

#### **Limited Three (3) year General Warranty:**

Subject to the more limited one (1) year warranty set out below, North and South America: Three (3) years warranty for all parts excluding the lamp, three (3) years for labor, and one (1) year for the original lamp from the date of the first consumer purchase.

Other regions or countries: Please check with your local dealer or local ViewSonic® office for the warranty information.

#### **Limited One (1) year Heavy Usage Warranty:**

Under heavy usage settings, where a projector's use includes more than fourteen (14) hours average daily usage, North and South America: One (1) year warranty for all parts excluding the lamp, one (1) year for labor, and ninety (90) days for the original lamp from the date of the first consumer purchase; Europe: One (1) year warranty for all parts excluding the lamp, one (1) year for labor, and ninety (90) days for the original lamp from the date of the first consumer purchase. Other regions or countries: Please check with your local dealer or local ViewSonic® office for the warranty information. Lamp warranty subject to terms and conditions, verification and approval. Applies to manufacturer's installed lamp only. All accessory lamps purchased separately are warranted for 90 days.

#### **Who the warranty protects:**

This warranty is valid only for the first consumer purchaser.



## **What the warranty does not cover:**

1. Any product on which the serial number has been defaced, modified, or removed.
2. Damage, deterioration, or malfunction resulting from:
  - » Accident, misuse, neglect, fire, water, lightning, or other acts of nature, unauthorized product modification, or failure to follow instructions supplied with the product.
  - » Operation outside of product specifications.
  - » Operation of the product for other than the normal intended use or not under normal conditions.
  - » Repair or attempted repair by anyone not authorized by ViewSonic®.
  - » Any damage of the product due to shipment.
  - » Removal or installation of the product.
  - » Causes external to the product, such as electric power fluctuations or failure.
  - » Use of supplies or parts not meeting Viewsonic's specifications.
  - » Normal wear and tear.
  - » Any other cause which does not relate to a product defect.
3. Removal, installation, and set-up service charges.

## **How to get service:**

1. For information about receiving service under warranty, contact ViewSonic® Customer Support (Please refer to the "Customer Support" page). You will need to provide your product's serial number.
2. To obtain warranted service, you will be required to provide: (a) the original dated sales slip, (b) your name, (c) your address, (d) a description of the problem, and (e) the serial number of the product.
3. Take or ship the product, freight prepaid, in the original container to an authorized ViewSonic® service center or ViewSonic®.
4. For additional information or the name of the nearest ViewSonic® service center, contact ViewSonic®.

## **Limitation of implied warranties:**

There are no warranties, express or implied, which extend beyond the description contained herein including the implied warranty of merchantability and fitness for a particular purpose.

**Exclusion of damages:**

ViewSonic's liability is limited to the cost of repair or replacement of the product. ViewSonic® shall not be liable for:

1. Damage to other property caused by any defects in the product, damages based upon inconvenience, loss of use of the product, loss of time, loss of profits, loss of business opportunity, loss of goodwill, interference with business relationships, or other commercial loss, even if advised of the possibility of such damages.
2. Any other damages, whether incidental, consequential or otherwise.
3. Any claim against the customer by any other party.

**Effect of state law:**

This warranty gives you specific legal rights, and you may also have other rights which vary from local authority. Some local governments do not allow limitations on implied warranties and/or do not allow the exclusion of incidental or consequential damages, so the above limitations and exclusions may not apply to you.

**Sales outside the U.S.A. and Canada:**

For warranty information and service on ViewSonic® products sold outside of the U.S.A. and Canada, contact ViewSonic® or your local ViewSonic® dealer.

The warranty period for this product in mainland China (Hong Kong, Macao, and Taiwan Excluded) is subject to the terms and conditions of the Maintenance Guarantee Card.

For users in Europe and Russia, full details of warranty provided can be found at: <http://www.viewsonic.com/eu/> under "Support/Warranty Information".

# Mexico Limited Warranty

## ViewSonic® Projector

### What the warranty covers:

ViewSonic® warrants its products to be free from defects in material and workmanship, under normal use, during the warranty period. If a product proves to be defective in material or workmanship during the warranty period, ViewSonic® will, at its sole option, repair or replace the product with a like product. Replacement product or parts may include remanufactured or refurbished parts or components & accessories.

### How long the warranty is effective:

3 years for all parts excluding the lamp, 3 years for labor, 1 year for the original lamp from the date of the first consumer purchase.

Lamp warranty subject to terms and conditions, verification and approval. Applies to manufacturer's installed lamp only.

All accessory lamps purchased separately are warranted for 90 days.

### Who the warranty protects:

This warranty is valid only for the first consumer purchaser.

### What the warranty excludes and does not cover:

1. Any product on which the serial number has been defaced, modified or removed.
2. Damage, deterioration, or malfunction resulting from:
  - » Accident, misuse, neglect, fire, water, lightning, or other acts of nature, unauthorized product modification, unauthorized attempted repair, or failure to follow instructions supplied with the product.
  - » Any damage of the product due to shipment.
  - » Causes external to the product, such as electrical power fluctuations or failure.
  - » Use of supplies or parts not meeting ViewSonic®'s specifications.
  - » Normal wear and tear.
  - » Any other cause which does not relate to a product defect.
3. Any product exhibiting a condition commonly known as "image burn-in" which results when a static image is displayed on the product for an extended period of time.
4. Removal, installation, insurance, and set-up service charges.

**How to get service:**

For information about receiving service under warranty, contact ViewSonic® Customer Support (Please refer to the attached “Customer Service” page). You will need to provide your product’s serial number, so please record the product information in the space provided below on your purchase for your future use. Please retain your receipt of proof of purchase to support your warranty claim.

**For Your Records**

Product Name: \_\_\_\_\_ Model Number: \_\_\_\_\_

Document Number: \_\_\_\_\_ Serial Number: \_\_\_\_\_

Purchase Date: \_\_\_\_\_ Extended Warranty Purchase? \_\_\_\_\_ (Y/N)

If so, what date does warranty expire? \_\_\_\_\_

1. To obtain warranty service, you will be required to provide (a) the original dated sales slip, (b) your name, (c) your address, (d) a description of the problem, and (e) the serial number of the product.
2. Take or ship the product, in the original container packaging, to an authorized ViewSonic® service center.
3. Round trip transportation costs for in-warranty products will be paid by ViewSonic®.

**Limitation of implied warranties:**

There are no warranties, express or implied, which extend beyond the description contained herein including the implied warranty of merchantability and fitness for a particular purpose.

**Exclusion of damages:**

ViewSonic®’s liability is limited to the cost of repair or replacement of the product. ViewSonic® shall not be liable for:

1. Damage to other property caused by any defects in the product, damages based upon inconvenience, loss of use of the product, loss of time, loss of profits, loss of business opportunity, loss of goodwill, interference with business relationships, or other commercial loss, even if advised of the possibility of such damages.
2. Any other damages, whether incidental, consequential or otherwise.
3. Any claim against the customer by any other party.
4. Repair or attempted repair by anyone not authorized by ViewSonic®.

Contact Information for Sales & Authorized Service (Centro Autorizado de Servicio) within Mexico:	
<b>Name, address, of manufacturer and importers:</b> México, Av. de la Palma #8 Piso 2 Despacho 203, Corporativo Interpalmas, Col. San Fernando Huixquilucan, Estado de México Tel: (55) 3605-1099 <a href="http://www.viewsonic.com/la/soporte/index.htm">http://www.viewsonic.com/la/soporte/index.htm</a>	
NÚMERO GRATIS DE ASISTENCIA TÉCNICA PARA TODO MÉXICO: 001.866.823.2004	
<b>Hermosillo:</b> Distribuciones y Servicios Computacionales SA de CV. Calle Juárez 284 local 2 Col. Bugambilias C.P: 83140 Tel: 01-66-22-14-9005 E-Mail: <a href="mailto:disc2@hmo.megared.net.mx">disc2@hmo.megared.net.mx</a>	<b>Villahermosa:</b> Compumantenimientos Garantizados, S.A. de C.V. AV. GREGORIO MENDEZ #1504 COL, FLORIDA C.P. 86040 Tel: 01 (993) 3 52 00 47 / 3522074 / 3 52 20 09 E-Mail: <a href="mailto:compumantenimientos@prodigy.net.mx">compumantenimientos@prodigy.net.mx</a>
<b>Puebla, Pue. (Matriz):</b> RENTA Y DATOS, S.A. DE C.V. Domicilio: 29 SUR 721 COL. LA PAZ 72160 PUEBLA, PUE. Tel: 01(52).222.891.55.77 CON 10 LINEAS E-Mail: <a href="mailto:datos@puebla.megared.net.mx">datos@puebla.megared.net.mx</a>	<b>Veracruz, Ver.:</b> CONEXION Y DESARROLLO, S.A DE C.V. Av. Americas # 419 ENTRE PINZÓN Y ALVARADO Fracc. Reforma C.P. 91919 Tel: 01-22-91-00-31-67 E-Mail: <a href="mailto:gacosta@qplus.com.mx">gacosta@qplus.com.mx</a>
<b>Chihuahua:</b> Soluciones Globales en Computación C. Magisterio # 3321 Col. Magisterial Chihuahua, Chih. Tel: 4136954 E-Mail: <a href="mailto:Cefeo@soluglobales.com">Cefeo@soluglobales.com</a>	<b>Cuernavaca:</b> Compusupport de Cuernavaca SA de CV Francisco Leyva # 178 Col. Miguel Hidalgo C.P. 62040, Cuernavaca Morelos Tel: 01 777 3180579 / 01 777 3124014 E-Mail: <a href="mailto:aquevedo@compusupportcva.com">aquevedo@compusupportcva.com</a>
<b>Distrito Federal:</b> QPLUS, S.A. de C.V. Av. Coyoacán 931 Col. Del Valle 03100, México, D.F. Tel: 01(52)55-50-00-27-35 E-Mail : <a href="mailto:gacosta@qplus.com.mx">gacosta@qplus.com.mx</a>	<b>Guadalajara, Jal.:</b> SERVICRECE, S.A. de C.V. Av. Niños Héroes # 2281 Col. Arcos Sur, Sector Juárez 44170, Guadalajara, Jalisco Tel: 01(52)33-36-15-15-43 E-Mail: <a href="mailto:mmiranda@servicrece.com">mmiranda@servicrece.com</a>
<b>Guerrero Acapulco:</b> GS Computación (Grupo Sesicomp) Progreso #6-A, Colo Centro 39300 Acapulco, Guerrero Tel: 744-48-32627	<b>Monterrey:</b> Global Product Services Mar Caribe # 1987, Esquina con Golfo Pérsico Fracc. Bernardo Reyes, CP 64280 Monterrey N.L. México Tel: 8129-5103 E-Mail: <a href="mailto:aydeem@gps1.com.mx">aydeem@gps1.com.mx</a>
<b>MERIDA:</b> ELECTROSER Av Reforma No. 403Gx39 y 41 Mérida, Yucatán, México CP97000 Tel: (52) 999-925-1916 E-Mail: <a href="mailto:rrrb@sureste.com">rrrb@sureste.com</a>	<b>Oaxaca, Oax.:</b> CENTRO DE DISTRIBUCION Y SERVICIO, S.A. de C.V. Murguía # 708 P.A., Col. Centro, 68000, Oaxaca Tel: 01(52)95-15-15-22-22 Fax: 01(52)95-15-13-67-00 E-Mail: <a href="mailto:gpotai2001@hotmail.com">gpotai2001@hotmail.com</a>
<b>Tijuana:</b> STD Av Ferrocarril Sonora #3780 L-C Col 20 de Noviembre Tijuana, Mexico	<b>FOR USA SUPPORT:</b> ViewSonic® Corporation 381 Brea Canyon Road, Walnut, CA. 91789 USA Tel: 800-688-6688 E-Mail: <a href="http://www.viewsonic.com">http://www.viewsonic.com</a>

