

USER MANUAL

G-MASTER

LCD Monitor

ENGLISH

G-MASTER GB2470HSU
G-MASTER G2470HSU
G-MASTER G2470HS
G-MASTER GB2770HSU
G-MASTER G2770HSU
G-MASTER G2770HS
G-MASTER GB2770QSU
G-MASTER G2770QSU

Thank you very much for choosing the iiyama LCD monitor.

We recommend that you take a few minutes to read carefully through this brief but comprehensive manual before installing and switching on the monitor. Please keep this manual in a safe place for your future reference.



Dear user, we congratulate you on the purchase of your iiyama LCD.

For details on warranty and locally used pixel policies that apply directly after installation of your product please check the iiyama website.

To report a fault, please contact your local support centre found at <https://iiyama.com>

Things to check before you call the iiyama information line

- | if the power cable is connected securely and turned on?
- | if the display has been turned on?
- | if the signal cable is connected securely and the correct input selected?
- | if the computer has been restarted with the display connected?
- | if the graphics card is correctly installed with the latest drivers possible?
- | if the correct native resolution has been selected via 'Display Properties'?
- | If the R/G/B signal configuration is correct?
- | if the displays On Screen Menu is shown?
- | if the correct brightness and contrast settings have been set?
- | if given display tolerances and compatibility have been considered?
- | if via the On Screen Menu you have performed a Factory Reset/Recall?

Before reporting the screen defect, please prepare the following information/evidence:

- | model number *
- | purchase receipt and serial number *
- | name and address for collection
- | telephone/fax number, for availability during the day
- | convenient collection date (date, time)
- | short description of the defect

Important Note:

If there is no fault found in the collected equipment after inspection, the transferring party shall incur charges for transport and administration.

If you have checked all of the above and there is still no picture, call our information line for assistance in your country.

Feedback on health and safety issues

If you have any health and safety concerns or questions about the product (including when using the product), please contact iiyama support through our website. You can also contact us by calling +31 204460404. After receiving your feedback, we will ask the responsible unit to handle it as soon as possible and a dedicated person will get back to you. Your feedback will also be recorded and incorporated into our evaluation for improvements

* see the identification plate on the back of the case.

CE MARKING DECLARATION OF CONFORMITY

This LCD monitor complies with the requirements of the EC/EU Directive 2014/30/EU "EMC Directive", 2014/35/EU "Low Voltage Directive", 2009/125/EC "ErP Directive" and 2011/65/EU "RoHS Directive".

The electro-magnetic susceptibility has been chosen at a level that gives correct operation in residential areas, business and light industrial premises and small-scale enterprises, inside as well as outside of the buildings. All places of operation are characterized by their connection to the public low voltage power supply system.

IYAMA CORPORATION: Wijkmeerstraat 8, 2131 HA Hoofddorp, The Netherlands

Model No. : PL2470H, PL2770H, PL2770Q



We recommend recycling of used product. Please contact your dealer or iiyama service center. Recycle information is obtained via the Internet, using the address: <https://iiyama.com>

You can access the Web page of different countries from there.

- We reserve the right to change specifications without notice.
- All trademarks used in this user manual are the property of their respective owners.
- Eprel registration number

GB2470HSU-B6 : 1956447 GB2470HSU-W6 : 1956472 G2470HSU-B6 : 1956491 G2470HS-B1 : 2009355
GB2770HSU-B6 : 1957175 GB2770HSU-W6 : 1957208 G2770HSU-B6 : 1957183 G2770HS-B1 : 2010228
GB2770QSU-B6 : 1946195 GB2770QSU-W6 : 1946249 G2770QSU-B6 : 1946260

TABLE OF CONTENTS

FOR YOUR SAFETY.....	1
SAFETY PRECAUTIONS.....	1
SPECIAL NOTES ON LCD MONITORS.....	3
CUSTOMER SERVICE	3
CLEANING	3
BEFORE YOU OPERATE THE MONITOR.....	4
FEATURES.....	4
CHECKING THE CONTENTS OF THE PACKAGE	4
USING ARM OR STAND.....	5
FITTING AND REMOVAL OF STAND :	
G-MASTER GB2470HSU / G-MASTER GB2770HSU /	
G-MASTER GB2770QSU	7
FITTING AND REMOVAL OF STAND :	
G-MASTER G2470HSU / G-MASTER G2470HS /	
G-MASTER G2770HSU / G-MASTER G2770HS /	
G-MASTER G2770QSU.....	8
CONTROLS AND CONNECTORS :	
G-MASTER GB2470HSU / G-MASTER GB2770HSU /	
G-MASTER GB2770QSU	10
CONTROLS AND CONNECTORS :	
G-MASTER G2470HSU / G-MASTER G2470HS /	
G-MASTER G2770HSU / G-MASTER G2770HS /	
G-MASTER G2770QSU.....	11
CONNECTING YOUR MONITOR :	
G-MASTER GB2470HSU / G-MASTER GB2770HSU /	
G-MASTER GB2770QSU	12
CONNECTING YOUR MONITOR :	
G-MASTER G2470HSU / G-MASTER G2470HS /	
G-MASTER G2770HSU / G-MASTER G2770HS /	
G-MASTER G2770QSU.....	13
COMPUTER SETTING	14
ADJUSTING HEIGHT AND VIEWING ANGLE :	
G-MASTER GB2470HSU / G-MASTER GB2770HSU /	
G-MASTER GB2770QSU	14
ADJUSTING VIEWING ANGLE :	
G-MASTER G2470HSU / G-MASTER G2470HS /	
G-MASTER G2770HSU / G-MASTER G2770HS /	
G-MASTER G2770QSU.....	15
OPERATING THE MONITOR.....	16
ADJUSTMENT MENU CONTENTS.....	17

STANDBY FEATURE	29
TROUBLE SHOOTING	30
RECYCLING INFORMATION.....	31
APPENDIX	32
SPECIFICATIONS : G-MASTER GB2470HSU-B6 / W6	32
SPECIFICATIONS : G-MASTER G2470HSU-B6 / G2470HS-B1 ...	33
SPECIFICATIONS : G-MASTER GB2770HSU-B6 / W6	34
SPECIFICATIONS : G-MASTER G2770HSU-B6 / G2770HS-B1 ...	35
SPECIFICATIONS : G-MASTER GB2770QSU-B6 / W6	36
SPECIFICATIONS : G-MASTER G2770QSU-B6.....	37
DIMENSIONS : G-MASTER GB2470HSU.....	38
DIMENSIONS : G-MASTER G2470HSU / G2470HS	38
DIMENSIONS : G-MASTER GB2770HSU.....	39
DIMENSIONS : G-MASTER G2770HSU / G2770HS	39
DIMENSIONS : G-MASTER GB2770QSU.....	40
DIMENSIONS : G-MASTER G2770QSU	40
COMPLIANT TIMING	41

FOR YOUR SAFETY

SAFETY PRECAUTIONS

WARNING

STOP OPERATING THE MONITOR IF YOU ARE AWARE OF ANY PROBLEMS

If you notice any abnormal phenomena such as smoke, strange sounds or fumes, unplug the monitor and contact your dealer or iiyama service center immediately. Further use may be dangerous and can cause fire or electric shock.

NEVER REMOVE THE CABINET

High voltage circuits are inside the monitor. Removing the cabinet may expose you to the danger of fire or electric shock.

DO NOT PUT ANY OBJECT INTO THE MONITOR

Do not put any solid objects or liquids such as water into the monitor. In case of an accident, unplug your monitor immediately and contact your dealer or iiyama service center. Using the monitor with any object inside may cause fire, electric shock or damage.

INSTALL THE MONITOR ON A FLAT, STABLE SURFACE

The monitor may cause an injury if it falls or is dropped.

DO NOT USE THE MONITOR NEAR WATER

Do not use where water may be splashed or spilt onto the monitor as it may cause fire or electric shock.

OPERATE UNDER THE SPECIFIED POWER SUPPLY

Be sure to operate the monitor only with the specified power supply. Use of an incorrect voltage will cause malfunction and may cause fire or electric shock.

PROTECT THE CABLES

Do not pull or bend the power cable and signal cable. Do not place the monitor or any other heavy objects on the cables. If damaged, the cables may cause fire or electric shock.

ADVERSE WEATHER CONDITIONS

It is advisable not to operate the monitor during a heavy thunder storm as the continual breaks in power may cause malfunction. It is also advised not to touch the plug in these circumstances as it may cause electric shock.

CAUTION

INSTALLATION LOCATION

Do not install the monitor where sudden temperature changes may occur, or in humid, dusty or smoky areas as it may cause fire, electric shock or damage. You should also avoid areas where the sun shines directly on the monitor.

DO NOT PLACE THE MONITOR IN A HAZARDOUS POSITION

The monitor may topple and cause injury if not suitably located. Please also ensure that you do not place any heavy objects on the monitor, and that all cables are routed such that children may not pull the cables and possibly cause injury.

MAINTAIN GOOD VENTILATION

Ventilation slots are provided to keep the monitor from overheating. Covering the slots may cause fire. To allow adequate air circulation, place the monitor at least 10 cm (or 4 inches) from any walls. When removing the tilt stand, the ventilation slots on the back side of the monitor can be blocked. This may overheat the monitor and may cause fire or damage. Make sure to allow enough ventilation when removing the tilt stand. Operating the monitor on its back, side, upside down or on a carpet or any other soft material may also cause damage.

DISCONNECT THE CABLES WHEN YOU MOVE THE MONITOR

When you move the monitor, turn off the power switch, unplug the monitor and be sure the signal cable is disconnected. If you do not disconnect them, it may cause fire or electric shock.

UNPLUG THE MONITOR

If the monitor is not in use for a long period of time it is recommended that it is left unplugged to avoid accidents.

HOLD THE PLUG WHEN DISCONNECTING

To disconnect the power cable or signal cable, always pull it by the plug. Never pull on the cable itself as this may cause fire or electric shock.

DO NOT TOUCH THE PLUG WITH WET HANDS

Pulling or inserting the plug with wet hands may cause electric shock.

WHEN YOU INSTALL THE MONITOR ON YOUR COMPUTER

Be sure the computer is strong enough to hold the weight of the monitor, otherwise, you may damage your computer.

CAREFUL! PROTECT YOUR HANDS AND FINGERS

- Be careful not to hurt your fingers or hands when you change the height or the angle.
- Injury can occur if care is not taken to avoid finger contact with the displays base when adjusting the height. (Just for height adjustable model.)

REMARK FOR 24/7 USAGE

This product is not specifically designed for 24/7 usage in all environments.

REMARK SPECIFIC TO DESKTOP USE

This product is designed for desktop use, not for digital signage (electronic signboard) applications such as ceiling hanging or wall mounting.

OTHERS

ERGONOMIC RECOMMENDATIONS

To eliminate eye fatigue, do not operate the monitor against a bright background or in a dark room. For optimal viewing comfort, the monitor should be just below eye level and 40-60 cm (16-24 inches) away from your eyes. When using the monitor over a prolonged time, a ten minute break every hour is recommended as looking at the screen continuously can cause eye strain.

SPECIAL NOTES ON LCD MONITORS

The following symptoms are normal with LCD monitors and do not indicate a problem.

- NOTE**
- When you first turn on the LCD monitor, the picture may not fit in the display area because of the type of computer that is used. In this case, adjust the picture position to the correct position.
 - You may find slightly uneven brightness on the screen depending on the desktop pattern you use.
 - Due to the nature of the LCD screen, an afterimage of the previous screen may remain after switching the image, when the same image is displayed for hours. In this case, the screen can be recovered slowly by changing the image or turning off the Power Switch for some hours.

CUSTOMER SERVICE

- NOTE**
- If you have to return your unit for service and the original packaging has been discarded, please contact your dealer or iiyama service center for advice or replacement packaging.

CLEANING

- WARNING**
- If you drop any materials or liquids such as water into the monitor when cleaning, unplug the power cable immediately and contact your dealer or iiyama service center.

- CAUTION**
- For safety reasons, turn off the power switch and unplug the monitor before you clean it.

- NOTE**
- To protect the LCD panel, do not scratch or rub the screen with a hard object.
 - Never use any of the following strong solvents. These will damage the cabinet and the LCD screen.

Thinner	Spray-type cleaner
Benzine	Wax
Abrasive cleaner	Acid or Alkaline solvent

- Touching the cabinet with any product made from rubber or plastic for a long time may cause degeneration or loss of paint on the cabinet.

CABINET Stains can be removed with a cloth lightly moistened with a mild detergent solvent. Then wipe the cabinet with a soft dry cloth.

LCD Periodic cleaning with a soft dry cloth is recommended.

SCREEN Don't use tissue paper etc. because these will damage the LCD screen.

BEFORE YOU OPERATE THE MONITOR

FEATURES

- ◆ Supports Resolutions up to 1920 × 1080 :
G-MASTER GB2470HSU / G-MASTER G2470HSU / G-MASTER G2470HS
G-MASTER GB2770HSU / G-MASTER G2770HSU / G-MASTER G2770HS
- ◆ Supports Resolutions up to 2560 × 1440 :
G-MASTER GB2770QSU / G-MASTER G2770QSU
- ◆ High Contrast 1000:1 (Typical), Brightness 300cd/m² (Typical) :
G-MASTER GB2470HSU / G-MASTER G2470HSU / G-MASTER G2470HS
G-MASTER GB2770HSU / G-MASTER G2770HSU / G-MASTER G2770HS
- ◆ High Contrast 1200:1 (Typical), Brightness 400cd/m² (Typical) :
G-MASTER GB2770QSU / G-MASTER G2770QSU
- ◆ Moving Picture Response Time 0.2ms
- ◆ Flicker - Free
- ◆ Eyesafe[®] Certified
- ◆ Digital Character Smoothing
- ◆ 2 × 2W Stereo Speakers
- ◆ Standby Feature
- ◆ VESA Mounting Standard (100mm×100mm) Compliant
- ◆ Keyhole for Security Lock

CHECKING THE CONTENTS OF THE PACKAGE

The following accessories are included in your package. Check to see if they are enclosed with the monitor. If anything is missing or damaged, please contact your local iiyama dealer or regional iiyama office.

- | | | |
|-----------------------------|---|---------------------|
| ■ Power Cable* ¹ | ■ HDMI Cable | ■ DisplayPort Cable |
| ■ USB Cable* ⁴ | ■ Stand-Base with a screw* ² | ■ Strand-Neck |
| ■ Screwdriver* ² | ■ Stand-Base* ³ | ■ Safety Guide |
| ■ Quick Start Guide | | |

CAUTION

*¹ All guarantees and warranties are void for any problems or damage caused by a power cable not supplied by iiyama.

An approved power cable greater or equal to H05VVF, 3G, 0.75mm² must be used.

*² Accessory for G-MASTER GB2470HSU / G-MASTER GB2770HSU / G-MASTER GB2770QSU

*³ Accessory for G-MASTER G2470HSU / G-MASTER G2470HS / G-MASTER G2770HSU /
G-MASTER G2770HS / G-MASTER G2770QSU

*⁴ Accessory for G-MASTER GB2470HSU / G-MASTER GB2770HSU / G-MASTER GB2770QSU /
G-MASTER G2470HSU / G-MASTER G2770HSU / G-MASTER G2770QSU

USING ARM OR STAND

CAUTION

- This product is designed for desktop use, not for digital signage (electronic signboard) applications such as ceiling hanging or wall mounting.
- Before installation, make sure the display arm or desk arm stand is strong enough to hold the necessary weight of the monitor and the mount.
- Panel angle adjustment range : 23° upward and 5° downward
- This product cannot be used with the monitor screen facing downward/upward.

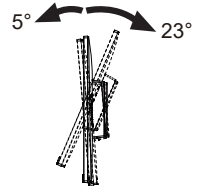

[DISPLAY ARM OR DESK ARM STAND]

CAUTION

- When you use with the display arm or desk arm stand, in consideration of thickness of the mounting stage, tighten the M4 Screws (4pcs) which "L" length is 7mm to fasten the monitor. Using the screw longer than this may cause electric shock or damage because it may contact with the electrical parts inside the monitor.

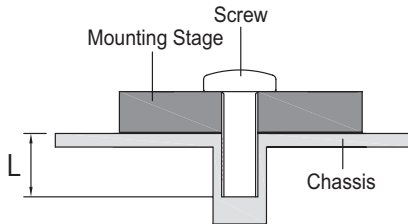

[ROTATING THE MONITOR]

• G-MASTER GB2470HSU / G-MASTER GB2770HSU / G-MASTER GB2770QSU

The monitor is designed to be compatible with both landscape and portrait modes.
Video card for portrait display will be required for rotating the image on the screen.

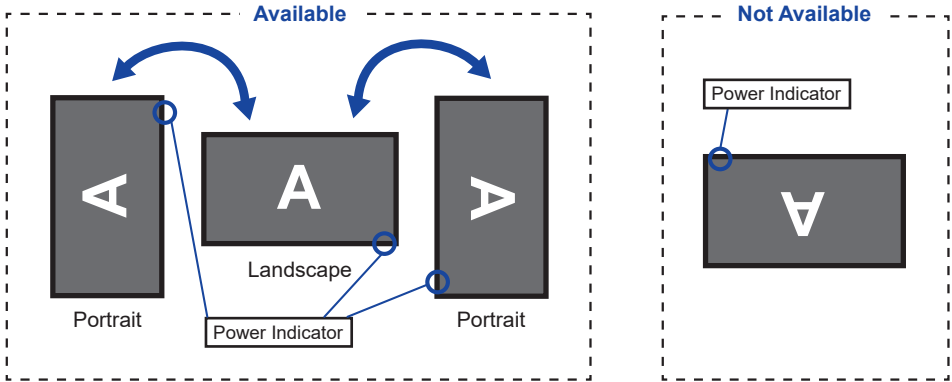

With Stand:

NOTE

- Adjust the monitor's height before panel rotation.
- Attempting to rotate the panel forcibly without adjusting the stand height may cause damage to the panel or the stand.

• G-MASTER G2470HSU / G-MASTER G2470HS / G-MASTER G2770HSU / G-MASTER G2770HS / G-MASTER G2770QSU

The monitor is designed to be compatible only with the landscape mode.

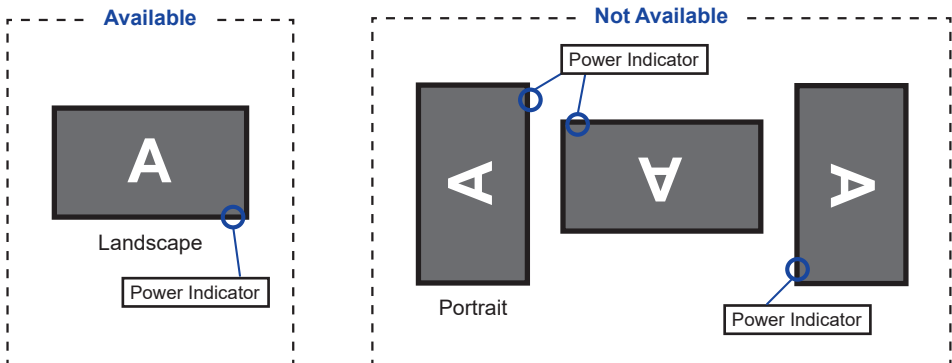

FITTING AND REMOVAL OF STAND : G-MASTER GB2470HSU / G-MASTER GB2770HSU / G-MASTER GB2770QSU

CAUTION

- Put the monitor on a stable surface. The monitor may cause injury or damage if it falls or is dropped.
- Do not give a strong impact to the monitor. It may cause damage.
- Unplug the monitor before removal or installation to avoid an electric shock or a damage.

<Installation>

- ① Put a piece of soft cloth on the table beforehand to prevent the monitor from being scratched. Lay the monitor flat on a table with front face down.
- ② Install the Stand-Neck to the monitor and then tighten the 'thumb screw' with the provided screwdriver to secure them.

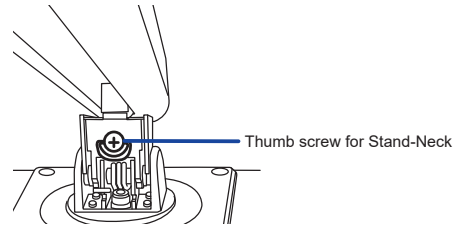
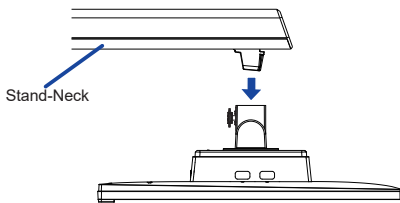

- ③ Install the Stand-Base to the Stand-Neck and then tighten the 'thumb screw' with the provided screwdriver to secure them.

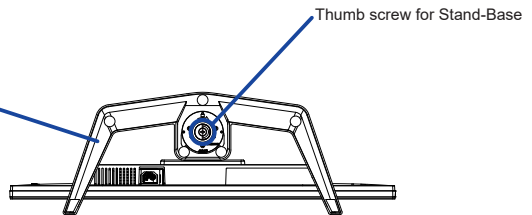
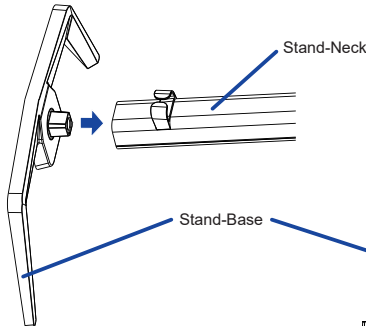

<Bottom view>

<Removal>

- ① Put a piece of soft cloth on the table beforehand to prevent the monitor from being scratched. Lay the monitor flat on a table with front face down.
- ② Loosen the 'thumb screw' with the provided screwdriver to remove the Stand-Base from the Stand-Neck.
- ③ Loosen the 'thumb screw' with the provided screwdriver to remove the Stand-Neck from the monitor.

FITTING AND REMOVAL OF STAND : G-MASTER G2470HSU / G-MASTER G2470HS / G-MASTER G2770HSU / G-MASTER G2770HS / G-MASTER G2770QSU

CAUTION

- Put the monitor on a stable surface. The monitor may cause injury or damage if it falls or is dropped.
- Do not give a strong impact to the monitor. It may cause damage.
- Unplug the monitor before removal or installation to avoid an electric shock or a damage.

<Installation>

- ① Combine the Stand-Neck and the Stand-Base.

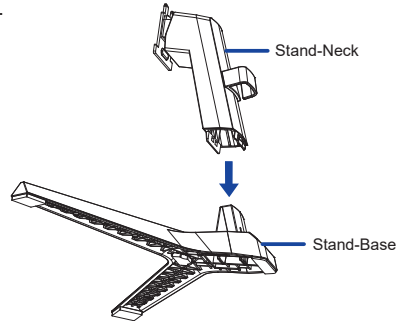

- ② Put a piece of soft cloth on the table beforehand to prevent the monitor from being scratched. Lay the monitor flat on a table with front face down.
- ③ Hold the monitor and install the assembled stand to the monitor until it clicks to secure.

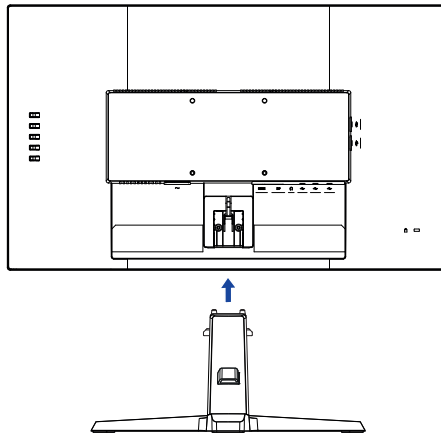

<Removal>

- ① Put a piece of soft cloth on the table beforehand to prevent the monitor from being scratched. Lay the monitor flat on a table with front face down.
- ② Keep pressing the Hooks inward to pull out the Stand-Base.
- ③ Press the release button and remove the Stand-Neck from the monitor.

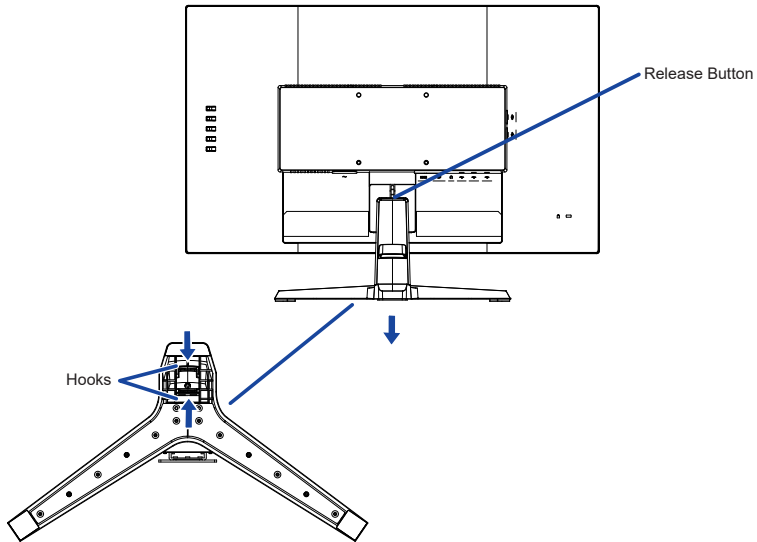

CONTROLS AND CONNECTORS : G-MASTER GB2470HSU / G-MASTER GB2770HSU / G-MASTER GB2770QSU

ENGLISH

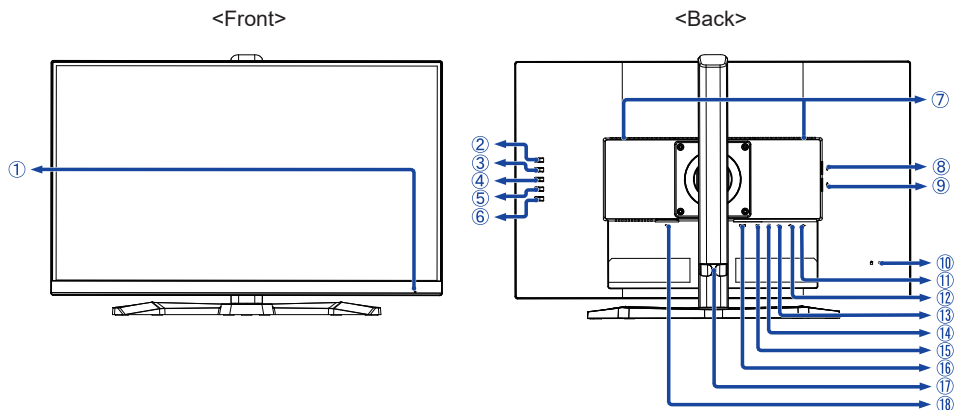

① Power Indicator

NOTE Blue: Normal operation
Orange: Standby mode

② Signal Select / Exit Button (INPUT) *

③ + / Volume Button (+) *

④ - / i-Style Color Button (-) *

⑤ Menu Button (MENU)

⑥ Power Switch (⏻)

⑦ Speakers

⑧ USB Downstream Connector (⚡ USB3.2 Gen 1: 5Gbps, 5V, 900mA)

⑨ USB Downstream Connector (⚡ USB3.2 Gen 1: 5Gbps, 5V, 900mA)

⑩ Keyhole for Security Lock

NOTE You can fasten a security lock and cable to prevent the monitor from being removed without your permission.

⑪ USB Downstream Connector (⚡ USB3.2 Gen 1: 5Gbps, 5V, 900mA)

⑫ USB Downstream Connector (⚡ USB3.2 Gen 1: 5Gbps, 5V, 900mA)

⑬ USB Upstream Connector (⚡)

⑭ Headphone Connector (🎧)

⑮ DisplayPort Connector (DP)

⑯ HDMI Connector (HDMI)

⑰ Cable Holder

⑱ AC Connector (~ : Alternating current)

* You can skip the Menu items and directly display an option setting screen or an adjustment scale.

CONTROLS AND CONNECTORS : G-MASTER G2470HSU / G-MASTER G2470HS / G-MASTER G2770HSU / G-MASTER G2770HS / G-MASTER G2770QSU

<Front>

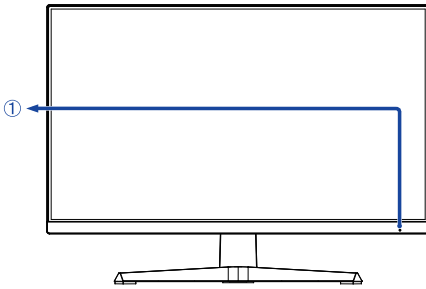

<Back>

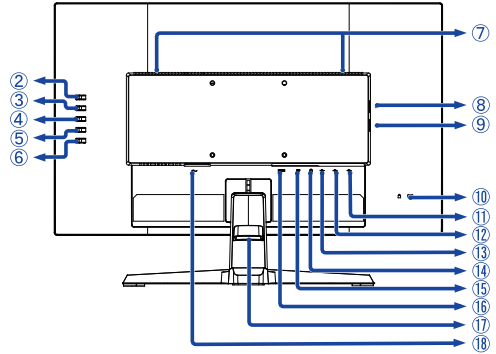

ENGLISH

① Power Indicator

NOTE Blue: Normal operation
Orange: Standby mode

② Signal Select / Exit Button (INPUT) *

③ + / Volume Button (+) *

④ - / i-Style Color Button (-) *

⑤ Menu Button (MENU)

⑥ Power Switch (⏻)

⑦ Speakers

⑧ USB Downstream Connector (⚡ USB3.2 Gen 1: 5Gbps, 5V, 900mA)

⑨ USB Downstream Connector (⚡ USB3.2 Gen 1: 5Gbps, 5V, 900mA)

⑩ Keyhole for Security Lock

NOTE You can fasten a security lock and cable to prevent the monitor from being removed without your permission.

⑪ USB Downstream Connector (⚡ USB3.2 Gen 1: 5Gbps, 5V, 900mA)

⑫ USB Downstream Connector (⚡ USB3.2 Gen 1: 5Gbps, 5V, 900mA)

⑬ USB Upstream Connector (⚡)

⑭ Headphone Connector (🎧)

⑮ DisplayPort Connector (DP)

⑯ HDMI Connector (HDMI)

⑰ Cable Holder

⑱ AC Connector (~ : Alternating current)

* You can skip the Menu items and directly display an option setting screen or an adjustment scale.

CONNECTING YOUR MONITOR : G-MASTER GB2470HSU / G-MASTER GB2770HSU / G-MASTER GB2770QSU

- ① Ensure that both the computer and the monitor are switched off.
- ② Connect the computer to the monitor with the signal cable.
- ③ Connect the computer to the monitor with the USB Cable.
- ④ Connect the Power Cable to the monitor first and then to the power source.
- ⑤ Turn on your monitor and computer.

- NOTE**
- Make sure that the building installation has a circuit breaker of 120/240V, 20A (maximum).
 - The signal cables used for connecting the computer and monitor may vary with the type of computer used. An incorrect connection may cause serious damage to both the monitor and the computer. The cable supplied with the monitor is for a standard connector. If a special cable is required please contact your local iiyama dealer or regional iiyama office.
 - The Class I pluggable equipment Type A must be connected to protective earth.
 - The socket-outlet shall be installed near the equipment and shall be easily accessible.
 - Excessive sound pressure from ear-/headphones can cause hearing damage/hearing loss.

[Example of Connection]

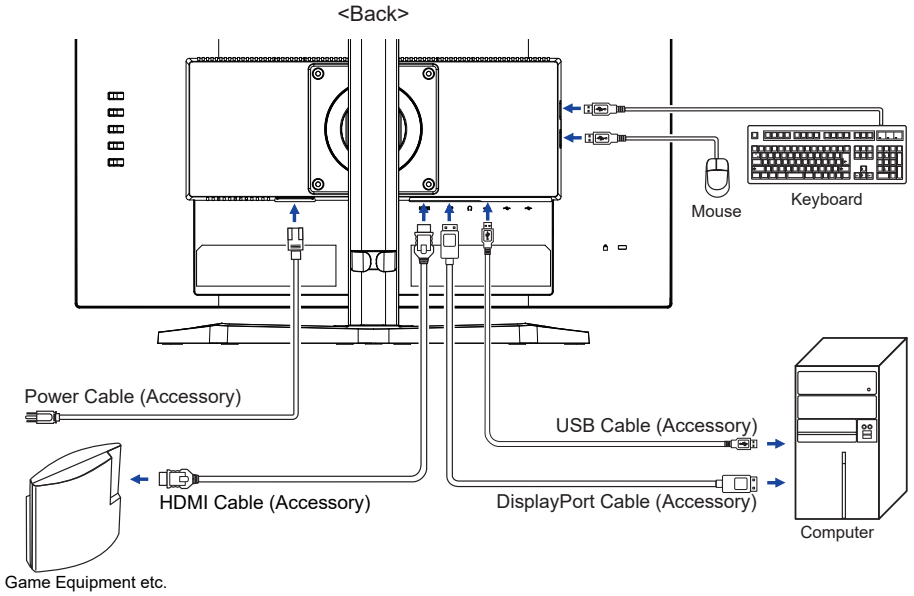

[Collect Cables]

Put the cables through the Cable Holder to bundle them.

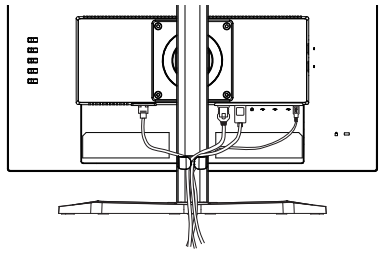

CONNECTING YOUR MONITOR : G-MASTER G2470HSU / G-MASTER G2470HS / G-MASTER G2770HSU / G-MASTER G2770HS / G-MASTER G2770QSU

- ① Ensure that both the computer and the monitor are switched off.
- ② Connect the computer to the monitor with the signal cable.
- ③ Connect the computer to the monitor with the USB Cable.
- ④ Connect the Power Cable to the monitor first and then to the power source.
- ⑤ Turn on your monitor and computer.

NOTE

- Make sure that the building installation has a circuit breaker of 120/240V, 20A (maximum).
- The signal cables used for connecting the computer and monitor may vary with the type of computer used. An incorrect connection may cause serious damage to both the monitor and the computer. The cable supplied with the monitor is for a standard connector. If a special cable is required please contact your local iiyama dealer or regional iiyama office.
- The Class I pluggable equipment Type A must be connected to protective earth.
- The socket-outlet shall be installed near the equipment and shall be easily accessible.
- Excessive sound pressure from ear/headphones can cause hearing damage/hearing loss.

[Example of Connection]

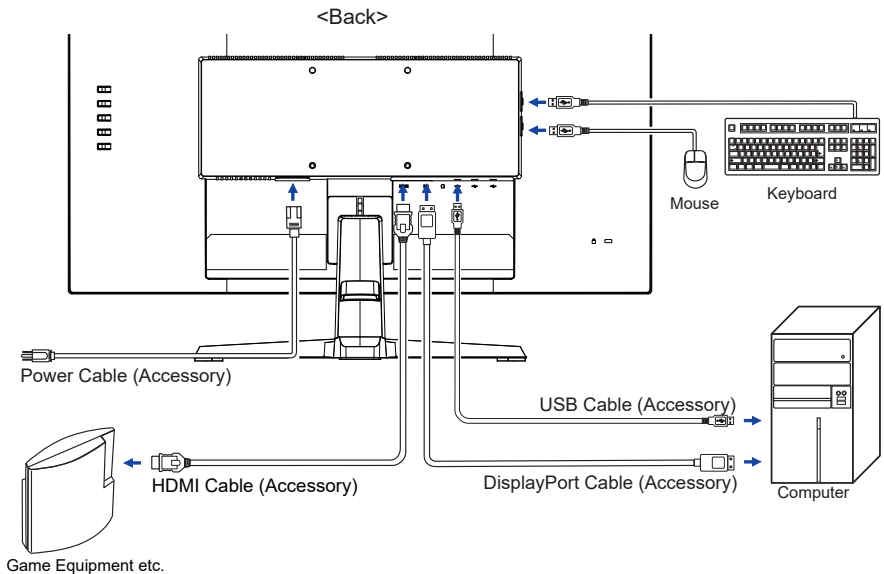

[Collect Cables]

Put the cables through the Cable Holder to bundle them.

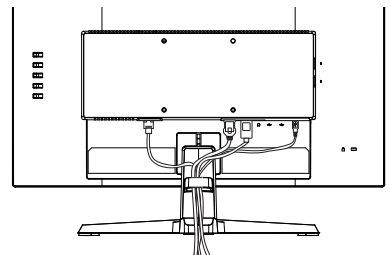

BEFORE YOU OPERATE THE MONITOR 13

COMPUTER SETTING

■ Signal Timing

Change to the desired signal timing listed on page 41: COMPLIANT TIMING.

ADJUSTING HEIGHT AND VIEWING ANGLE : G-MASTER GB2470HSU / G-MASTER GB2770HSU / G-MASTER GB2770QSU

- For optimal viewing it is recommended to position yourself directly opposite to the full face of the monitor, then adjust the monitor's height and angle to your own preference.
- Hold the panel so that the monitor does not topple when you change the monitor's height or angle.
- You are able to adjust the monitor's height up to 150mm, angle up to 45° right and left, 23° upward and 5° downward.

- NOTE**
- Do not touch the LCD screen when you change the height or the angle. It may cause damage or break the LCD screen.
 - Careful attention is required not to pinch your fingers or hands into the moving part of the stand when you change the angle.
 - Injury can occur if care is not taken to avoid finger contact with the displays base when adjusting the height.

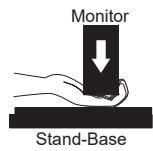
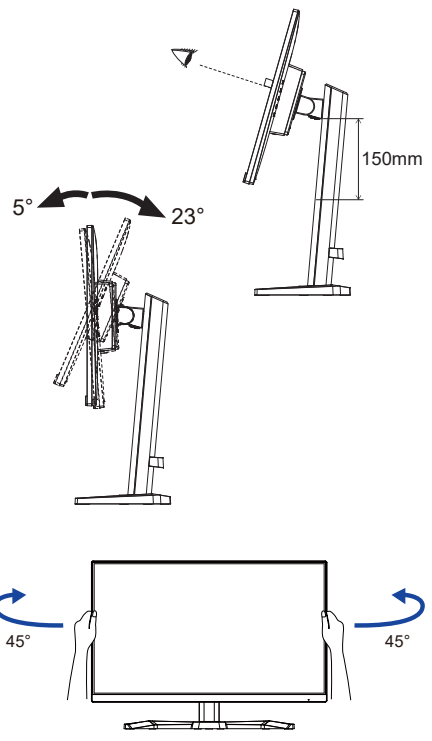

ADJUSTING VIEWING ANGLE : G-MASTER G2470HSU / G-MASTER G2470HS / G-MASTER G2770HSU / G-MASTER G2770HS / G-MASTER G2770QSU

- For optimal viewing it is recommended to look at the full face of the monitor.
- Hold the stand so that the monitor does not topple when you change the monitor's angle.
- You are able to adjust the monitor's angle up to 21.5° upward, 3.5° downward.
- In order to ensure a healthy and relaxed body position when using the monitor at visual display workstations, it is recommended that the adjusted tilt angle should not exceed 10°. Adjust the monitor's angle to your own preference.

NOTE

- Do not touch the LCD screen when you change the angle. It may cause damage or break the LCD screen.
- Careful attention is required not to catch your fingers or hands when you change the angle.

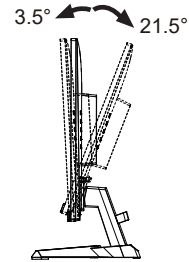
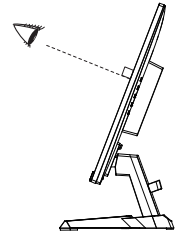

OPERATING THE MONITOR

To create the best picture, your iiyama LCD monitor has been preset at the factory with the COMPLIANT TIMING shown on page 41. You are also able to adjust the picture by following the button operation shown below.

- ① Press the **MENU** Button to start the On Screen Display feature.



- ② Use the **+ / -** Buttons to select the Menu which contains the item you want to adjust or set and then press the **MENU** Button.
- ③ Use the **+ / -** Buttons to highlight the desired adjustment / setting icon and then press the **MENU** Button.
- ④ Use the **+ / -** Buttons again to make the appropriate adjustment or setting and then press the **MENU** Button.
- ⑤ Press the **INPUT** Button to leave the menu, and the adjustment or setting you just made would be automatically saved.

For example, to correct for OSD vertical position, select Menu item of Setup Menu and then press the **MENU** Button. Then, select OSD Vertical Position by using the **+ / -** Buttons. An adjustment scale becomes active after you press the **MENU** Button.

Use the **+ / -** Buttons to change the OSD vertical position settings. The OSD vertical position of the overall display should be changing accordingly while you are doing this.

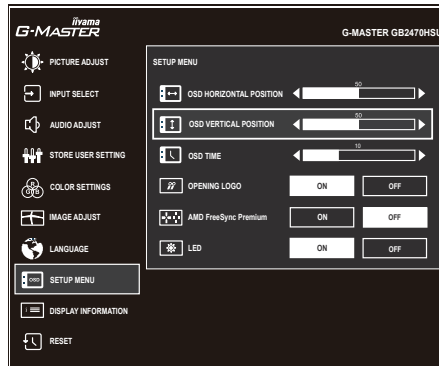

Press the **MENU** Button and finally the **INPUT** Button to close the On Screen Display feature. All changes are saved in the memory.

NOTE

- When button operations are aborted during adjustment, On-Screen Display disappears when the time set for the OSD Time has passed. Also, press the **INPUT** Button to quickly turn off the On-Screen Display.
- Any changes are automatically saved in the memory when the On Screen Display disappears. Turning off the power should be avoided while using the Menu.
- All adjustments have only one setting which applies to all signal timings.

ADJUSTMENT MENU CONTENTS



Picture Adjust *1

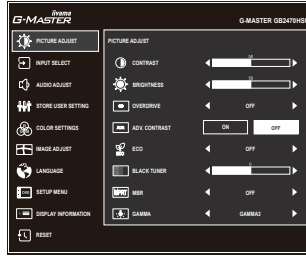

Adjustment Item	Problem / Option	Button to Press
Contrast	Too dark Too bright	
Brightness *2	Too dull Too intense	
Overdrive	Off / 1 / 2 / 3 / 4 / 5 It will improve the gray level response time of the LCD panel. A higher level results in a faster response time.	
Adv. Contrast *3	On	Increased Contrast Ratio
	Off	Typical Contrast Ratio
Eco	Off	Normal
	Mode1	Brightness of back-light is reduced.
	Mode2	Brightness of back-light is reduced more than Mode1.
Black Tuner	From -5 to +5 You can adjust Dark shades.	
	Gamma	
MBR *3,4	Off / 1 / 2 / 3 / 4 / 5 / 6 / 7 Improve the moving picture response time of the LCD panel.	
	Gamma	
Gamma	Gamma1	
	Gamma2	
	Gamma3	

- *1 The availability of each item depends on which item is activated. See the Function Correlation Matrix below for more details.
- *2 Adjust the Brightness when you are using the monitor in a dark room and feel the screen is too bright.
- *3 Not available when Adaptive Sync is active.
- *4 MBR is available only when the refresh rate is 75Hz or more.

■ **Function Correlation Matrix**

Active item Selected item	Picture Adjust			Image Adjust
	Adv.Contrast	Eco	MBR	i-Style (Standard, Sport Game, FPS Game, Strategy Game, Text)
Contrast	–	✓	✓	–
Brightness	–	–	–	–
Overdrive	✓	✓	–	–
Adv. Contrast	–	–	–	–
Eco	–	–	–	–
Black Tuner	✓	✓	–	–
MBR	–	–	–	–
Gamma	✓	✓	✓	✓

✓ : Available
 – : Not available



Input Select

Direct

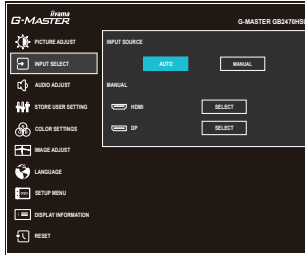

Adjustment Item	Option		
Input Source	Auto	Search for an available input source and select automatically.	
	Manual	HDMI	Select the Digital (HDMI) input.
		DP	Select the Digital (DisplayPort) input.

NOTE Input source is fixed, not selected automatically when HDMI and DisplayPort are selected.

Direct

You can skip the Menu items and directly display an option setting screen by using the following button operations.

- Input Select : Press the INPUT Button when the Menu is not displayed.





Audio Adjust

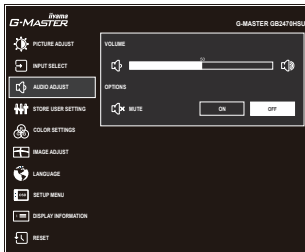

Adjustment Item	Problem / Option	Button to Press
Volume Direct	Too soft Too loud	<input type="button" value="+"/> <input type="button" value="-"/>
Mute	On	Turn off the sound temporarily.
	Off	Return the sound volume to the previous level.
NOTE Mute On and Off are switched as follows by pressing the + / - Buttons successively. <input type="button" value="→ On"/> → <input type="button" value="Off"/>		

Direct

You can skip the Menu items and directly display an adjustment scale by using the following button operations.

- Volume : Press the + Button when the Menu is not displayed.



Store User Setting

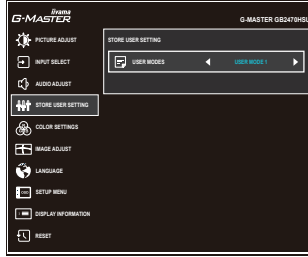

Adjustment Item	Option	
User Modes	User Mode 1	Save the settings of the screen adjustment.
	User Mode 2	Save the settings of the screen adjustment.
	User Mode 3	Save the settings of the screen adjustment.
<p>NOTE You can memorize your customized monitor settings.</p> <p>The following settings can be memorized: Contrast, Brightness, Overdrive, Adv. Contrast, Eco, Black Tuner, MBR, Gamma, Volume, Mute, Color Settings, 6-Axis, User Preset, X-Res, Sharp and Soft, HDMI Range, Direct Drive Mode, Video Mode Adjust, Adaptive Sync</p>		





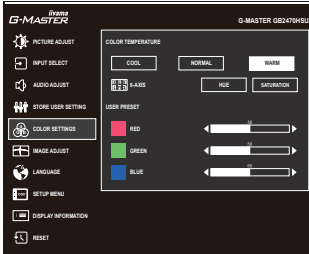

Color Settings

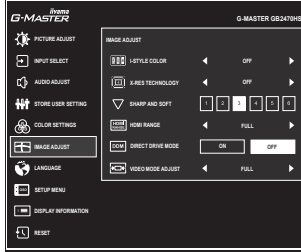

Adjustment Item	Problem / Option		Button to Press	
Color Temperature	Cool	Cool color		
	Normal	Normal color		
	Warm	Warm color		
6-Axis	Hue	Red	Too weak Too strong	<input type="button" value="+"/> <input type="button" value="-"/>
		Yellow		
		Green		
		Cyan		
		Blue		
		Magenta		
	Saturation	Red	Too weak Too strong	<input type="button" value="+"/> <input type="button" value="-"/>
		Yellow		
		Green		
		Cyan		
User Preset	Red	Too weak Too strong	<input type="button" value="+"/> <input type="button" value="-"/>	
	Green			
	Blue			

Image Adjust



Adjustment Item	Option	Button to Press
i-Style Color Direct	Off	Return to a state set by color adjustment except i-Style Color.
	Standard	For general windows environment and monitor default setting
	Sport Game	For Sports game environment
	FPS Game	For FPS game environment
	Strategy Game	For Strategy game environment
	Text	For text editing and viewing in a word processing environment
	User Mode 1	Applies customized monitor settings.
	User Mode 2	Applies customized monitor settings.
	User Mode 3	Applies customized monitor settings.
X-Res Technology	Off	Normal
	Soft	Enhance the picture edge.
	Middle	Enhance the picture edge more than the Soft option.
	Hard	Enhance the picture edge more than the Middle option.
Sharp and Soft	1 2 3 4 5 6	   <p>You can change the picture quality from 1 to 6 (sharp to soft). Press the + Button to change the picture quality in numerical order. Press the – Button to change the picture quality in reverse numerical order.</p>
HDMI Range *1	Full	For full-range color scale signal
	Limited	For limited color scale signal
Direct Drive Mode *2	On	Reduce the input-lag.
	Off	Typical
NOTE Changing Resolution and Refresh rate or turning Power Off/On might disable the Direct Drive Mode function.		

*1 Available for HDMI input only.

*2 Not available when Adv. Contrast or MBR is active.

Direct

You can skip the Menu items and directly display an option setting screen by using the following button operations.

- i-Style Color: Press the – Button when the Menu is not displayed.

Image Adjust

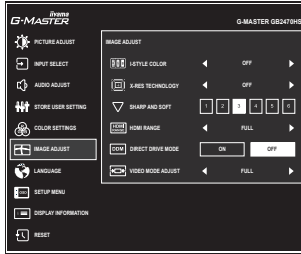

Adjustment Item	Option	
Video Mode Adjust *3	Full	Expansion display
	Aspect *4	Expansion display of Aspect
	Dot by dot *5	Display the picture dot by dot.
	17inch	Display the picture as 17 inch screen (5 : 4).
	19inch *6	Display the picture as 19 inch screen (5 : 4).
	19.5inch	Display the picture as 19.5 inch screen (16 : 9).
	21.5inch	Display the picture as 21.5 inch screen (16 : 9).
	23inch	Display the picture as 23 inch screen (16 : 9).
	23.6inch *6	Display the picture as 23.6 inch screen (16 : 9).
	23.8inch *6	Display the picture as 23.8 inch screen (16 : 9).
24inch *6	Display the picture as 24 inch screen (16 : 9).	

*3 See the table below for the functional interaction of Video Mode Adjust, Overdrive and Direct Drive Mode.

*4 Available only with 16:10, 5:4 and 4:3 resolutions.

*5 Available only at resolutions 1920 × 1080 or less.

*6 Available for G-MASTER GB2770HSU / G-MASTER G2770HSU / G-MASTER GB2770QSU / G-MASTER G2770QSU only.

Video Mode Adjust	Overdrive	Direct Drive Mode
Full / Aspect	selectable (keep current setting)	selectable (keep current setting)
Dot by dot / Picture size	gray out (set to off)	gray out (set to off)



Language

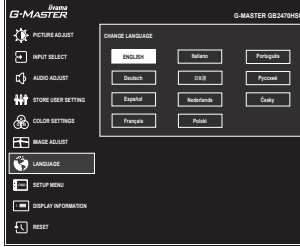

Adjustment Item	Option			
Language	English	English	Nederlands	Dutch
	Deutsch	German	Polski	Polish
	Español	Spanish	Português	Portuguese
	Français	French	Русский	Russian
	Italiano	Italian	Česky	Czech
	日本語	Japanese		

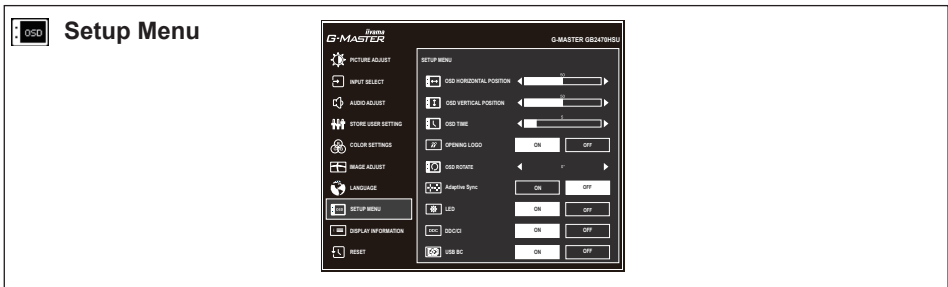

Adjustment Item	Problem / Option	Button to Press
OSD Horizontal Position	OSD is too left OSD is too right	<input type="button" value="+"/> <input type="button" value="-"/>
OSD Vertical Position	OSD is too low OSD is too high	<input type="button" value="+"/> <input type="button" value="-"/>
OSD Time	You can set the OSD display duration time between 5 and 30 seconds.	<input type="button" value="+"/> <input type="button" value="-"/>
Opening Logo	On G-MASTER Logo is displayed when the monitor is turned on.	<input type="button" value="+"/> <input type="button" value="-"/>
	Off G-MASTER Logo is not displayed when the monitor is turned on.	
OSD Rotate * ¹	Rotates the OSD. 0° (Normal) / +90° (Rotate right) / -90° (Rotate left)	<input type="button" value="+"/> <input type="button" value="-"/>
Adaptive Sync * ²	On Enable the Adaptive Sync function.	<input type="button" value="+"/> <input type="button" value="-"/>
	Off The Adaptive Sync function is turned off.	
LED	On The Power Indicator is turned On.	<input type="button" value="+"/> <input type="button" value="-"/>
	Off The Power Indicator is turned Off.	
NOTE Turn Off the Power Indicator when you are bothered by the light.		
DDC/CI	On DDC/CI is On.	<input type="button" value="+"/> <input type="button" value="-"/>
	Off DDC/CI is Off.	
USB BC* ³	On USB devices can be charged even when the monitor is not connected to a working computer with the included USB cable.	<input type="button" value="+"/> <input type="button" value="-"/>
	Off USB devices cannot be charged when the monitor is not connected to a working computer with the included USB cable.	
NOTE When the monitor is turned off, USB devices cannot be charged even when the USB BC function is on.		

*¹ Available for G-MASTER GB2470HSU / G-MASTER GB2770HSU / G-MASTER GB2770QSU only.
*² The availability depends on which item is activated. See the Function Correlation Matrix below for more details.
*³ Not available for G-MASTER G2470HS / G-MASTER G2770HS.

■ Function Correlation Matrix

Active item Selected Item	Picture Adjust			Image Adjust		
	Adv. Contrast	Eco	MBR	i-Style Color	Direct Drive Mode	Video Mode Adjust
				Standard Sport Game FPS Game Strategy Game Text		Dot by dot / Picture size
Adaptive Sync	—	✓	—	—	✓	—

✓ : Available
 — : Not available



Display Information



Displays information regarding the current input signal coming from the graphic card in your computer.

NOTE See your graphic card user guide for more information about changing the resolution and refresh.



Reset

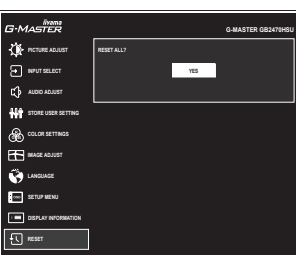

Adjustment Item	Option
Yes	Factory-preset data is restored.

● Lock Mode

<OSD Menu>

Hold the MENU button and turn on the monitor when the monitor is power-off, it will lock/unlock the OSD Lock function.

<Power Switch / OSD Menu>

Pressing and holding the MENU button for 5 seconds when Menu is not displayed, will lock/unlock the Power/OSD Lock function.

STANDBY FEATURE

This product features the standby function. When activated, it automatically reduces unnecessary power consumption of the monitor when your computer is not in use.

There is a standby step the monitor takes as described below. The standby function, including any timer settings is configured by the operating system. Check your operating system manual for information on how this can be configured.

■ Standby Mode

When the video signal from the computer is off, the monitor enters into Standby Mode which reduces the power consumption to less than 0.5W*. The screen becomes dark, and the power indicator turns to orange. From Standby Mode, the image reappears in several seconds when either the keyboard or the mouse are touched again.

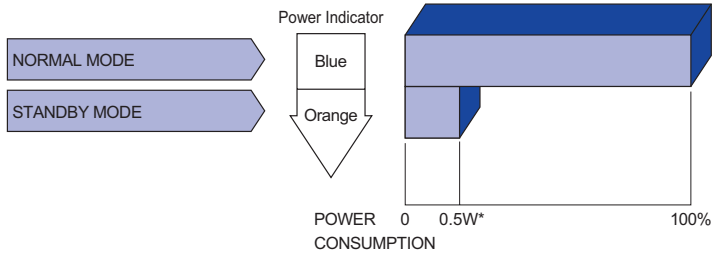

* When the USB devices are not connected.

TROUBLE SHOOTING

If the monitor fails to operate correctly, please follow the steps below for a possible solution.

1. Perform the adjustments described in OPERATING THE MONITOR, depending on the problem you have. If the monitor does not get a picture, skip to 2.
2. Consult the following items if you cannot find an appropriate adjustment item in OPERATING THE MONITOR or if the problem persists.
3. If you are experiencing a problem which is not described below or you cannot correct the problem, discontinue using the monitor and contact your dealer or iiyama service center for further assistance.

Problem

Check

- ① The picture does not appear.

(Power indicator does not light up.)

(Power indicator is blue.)

(Power indicator is orange.)

- ② The screen is not synchronized.

- ③ The screen position is not in the center.

- ④ The screen is too bright or too dark.

- ⑤ The screen is shaking.

- ⑥ No sound.

- ⑦ The sound is too loud or too quiet.

The Power Cable is firmly seated in the socket.

The Power Switch is turned ON.

The AC socket is live. Please check with another piece of equipment.

If the blank screen saver is in active mode, touch the keyboard or the mouse.

Increase the Contrast and/or Brightness.

The computer is ON.

The Signal Cable is properly connected.

The signal timing of the computer is within the specification of the monitor.

If the monitor is in standby mode, touch the keyboard or the mouse.

The computer is ON.

The Signal Cable is properly connected.

The signal timing of the computer is within the specification of the monitor.

The Signal Cable is properly connected.

The signal timing of the computer is within the specification of the monitor.

The signal timing of the computer is within the specification of the monitor.

The video output level of the computer is within the specification of the monitor.

The power voltage is within the specification of the monitor.

The signal timing of the computer is within the specification of the monitor.

The audio equipment (computer etc.) is ON.

The Volume is turned up.

The Mute is OFF.

The audio output level of the audio equipment is within the specification of the monitor.

The audio output level of the audio equipment is within the specification of the monitor.

RECYCLING INFORMATION

For better environment protection please don't dispose your monitor.
Please visit our web site: <https://iiyama.com> for monitor recycling.

APPENDIX

Design and specifications are subject to change without prior notice.

SPECIFICATIONS : G-MASTER GB2470HSU-B6 / W6

ENGLISH

Size Category	24"	
LCD Panel	Panel technology	Fast IPS
	Size	Diagonal: 23.8" (60.5cm)
	Pixel pitch	0.275mm H × 0.275mm V
	Brightness	300cd/m ² (Typical), 155cd/m ² (Default / Energy Saving)
	Contrast ratio	1000 : 1 (Typical), Advanced Contrast Function Available
	Viewable angle	Right / Left: 89 degrees each, Up / Down: 89 degrees each (Typical)
	MPRT	0.2ms
Display Colors	Approx. 16.7M	
Sync Frequency	HDMI: Horizontal: 30.0-225.0kHz, Vertical: 48-180Hz DisplayPort: Horizontal: 250.0kHz, Vertical: 48-180Hz	
Native Resolution	1920 × 1080, 2.1 MegaPixels	
Supported max. resolution	HDMI: 1920 × 1080, 180Hz DisplayPort: 1920 × 1080, 180Hz	
Input Connector	HDMI × 1, DisplayPort × 1	
Input Video Signal	HDMI, DisplayPort	
USB Standard	USB3.2 Gen 1 (5Gbps, DC5V, 900mA)	
Number of USB Ports	1 Upstream: Series B	
Connector shape	4 Downstream: Series A	
Headphone Connector	ø 3.5mm mini jack (Stereo)	
Speakers	2W × 2 (Stereo speakers)	
Maximum Screen Size	527.0mm W × 296.5mm H / 20.7" W × 11.7" H	
Power Source	100-240VAC, 50/60Hz, 1.5A	
Power Consumption*	18W (Typical) Standby mode: 0.5W maximum, Off mode: 0.3W maximum	
Dimensions / Net Weight	539.5 × 355.0 - 505.0 × 171.0mm / 21.2 × 14.0 - 19.9 × 6.7" (W×H×D) 4.5kg / 9.9lbs	
Height Adjustment Range	150mm	
Angle	Tilt: Upward: 23 degrees, Downward: 5 degrees Swivel: Left / Right: 45 degrees each Rotation: Clockwise / Counterclockwise: 90 degrees each	
Environmental Considerations	Operating: Temperature 0 to 40°C / 32 to 104°F Humidity 20 to 80% (No condensation) Storage: Temperature -20 to 60°C / -4 to 140°F Humidity 10 to 90% (No condensation)	
Approvals	CE, UKCA, TÜV-Bauart, EAC, VCCI, PSE, Eyesafe 2.0	

NOTE * When the USB devices are not connected.

SPECIFICATIONS : G-MASTER G2470HSU-B6 / G2470HS-B1

Size Category		24"
LCD Panel	Panel technology	Fast IPS
	Size	Diagonal: 23.8" (60.5cm)
	Pixel pitch	0.275mm H × 0.275mm V
	Brightness	300cd/m ² (Typical), 155cd/m ² (Default / Energy Saving)
	Contrast ratio	1000 : 1 (Typical), Advanced Contrast Function Available
	Viewable angle	Right / Left: 89 degrees each, Up / Down: 89 degrees each (Typical)
	MPRT	0.2ms
Display Colors		Approx. 16.7M
Sync Frequency		HDMI: Horizontal: 30.0-225.0kHz, Vertical: 48-180Hz DisplayPort: Horizontal: 250.0kHz, Vertical: 48-180Hz
Native Resolution		1920 × 1080, 2.1 MegaPixels
Supported max. resolution		HDMI: 1920 × 1080, 180Hz DisplayPort: 1920 × 1080, 180Hz
Input Connector		HDMI × 1, DisplayPort × 1
Input Video Signal		HDMI, DisplayPort
USB Standard* ²		USB3.2 Gen 1 (5Gbps, DC5V, 900mA)
Number of USB Ports* ²		1 Upstream: Series B
Connector shape		4 Downstream: Series A
Headphone Connector		ø 3.5mm mini jack (Stereo)
Speakers		2W × 2 (Stereo speakers)
Maximum Screen Size		527.0mm W × 296.5mm H / 20.7" W × 11.7" H
Power Source		100-240VAC, 50/60Hz, 1.5A
Power Consumption* ¹		18W (Typical) Standby mode: 0.5W maximum, Off mode: 0.3W maximum
Dimensions / Net Weight		539.5 × 393.5 × 192.5mm / 21.2 × 15.4 × 7.5" (W×H×D) 3.2kg / 7.1lbs
Tilt Angle		Upward: 21.5 degrees Downward: 3.5 degrees
Environmental Considerations		Operating: Temperature 0 to 40°C / 32 to 104°F Humidity 20 to 80% (No condensation) Storage: Temperature -20 to 60°C / -4 to 140°F Humidity 10 to 90% (No condensation)
Approvals		CE, UKCA, TÜV-Bauart, EAC, VCCI, PSE, Eyesafe 2.0

NOTE *¹ When the USB devices are not connected.

*² Not available for G-MASTER G2470HS.

SPECIFICATIONS : G-MASTER GB2770HSU-B6 / W6

Size Category		27"
LCD Panel	Panel technology	Fast IPS
	Size	Diagonal: 27.0" (68.6cm)
	Pixel pitch	0.311mm H × 0.311mm V
	Brightness	300cd/m ² (Typical), 155cd/m ² (Default / Energy Saving)
	Contrast ratio	1000 : 1 (Typical), Advanced Contrast Function Available
	Viewable angle	Right / Left: 89 degrees each, Up / Down: 89 degrees each (Typical)
	MPRT	0.2ms
Display Colors		Approx. 16.7M
Sync Frequency		HDMI: Horizontal: 30.0-225.0kHz, Vertical: 48-180Hz DisplayPort: Horizontal: 250.0kHz, Vertical: 48-180Hz
Native Resolution		1920 × 1080, 2.1 MegaPixels
Supported max. resolution		HDMI: 1920 × 1080, 180Hz DisplayPort: 1920 × 1080, 180Hz
Input Connector		HDMI × 1, DisplayPort × 1
Input Video Signal		HDMI, DisplayPort
USB Standard		USB3.2 Gen 1 (5Gbps, DC5V, 900mA)
Number of USB Ports Connector shape		1 Upstream: Series B 4 Downstream: Series A
Headphone Connector		ø 3.5mm mini jack (Stereo)
Speakers		2W × 2 (Stereo speakers)
Maximum Screen Size		596.7mm W × 335.7mm H / 23.4" W × 13.2" H
Power Source		100-240VAC, 50/60Hz, 1.5A
Power Consumption*		16W (Typical) Standby mode: 0.5W maximum, Off mode: 0.3W maximum
Dimensions / Net Weight		613.0 × 407.5 - 557.5 × 213.0mm / 24.1 × 16.0 - 21.9 × 8.3" (W×H×D) 5.4kg / 11.9lbs
Height Adjustment Range		150mm
Angle		Tilt: Upward: 23 degrees, Downward: 5 degrees Swivel: Left / Right: 45 degrees each Rotation: Clockwise / Counterclockwise: 90 degrees each
Environmental Considerations		Operating: Temperature 0 to 40°C / 32 to 104°F Humidity 20 to 80% (No condensation) Storage: Temperature -20 to 60°C / -4 to 140°F Humidity 10 to 90% (No condensation)
Approvals		CE, UKCA, TÜV-Bauart, EAC, VCCI, PSE, Eyesafe 2.0

NOTE * When the USB devices are not connected.

SPECIFICATIONS : G-MASTER G2770HSU-B6 / G2770HS-B1

Size Category		27"
LCD Panel	Panel technology	Fast IPS
	Size	Diagonal: 27.0" (68.6cm)
	Pixel pitch	0.311mm H × 0.311mm V
	Brightness	300cd/m ² (Typical), 155cd/m ² (Default / Energy Saving)
	Contrast ratio	1000 : 1 (Typical), Advanced Contrast Function Available
	Viewable angle	Right / Left: 89 degrees each, Up / Down: 89 degrees each (Typical)
	MPRT	0.2ms
Display Colors		Approx. 16.7M
Sync Frequency		HDMI: Horizontal: 30.0-225.0kHz, Vertical: 48-180Hz DisplayPort: Horizontal: 250.0kHz, Vertical: 48-180Hz
Native Resolution		1920 × 1080, 2.1 MegaPixels
Supported max. resolution		HDMI: 1920 × 1080, 180Hz DisplayPort: 1920 × 1080, 180Hz
Input Connector		HDMI × 1, DisplayPort × 1
Input Video Signal		HDMI, DisplayPort
USB Standard* ²		USB3.2 Gen 1 (5Gbps, DC5V, 900mA)
Number of USB Ports* ²		1 Upstream: Series B
Connector shape		4 Downstream: Series A
Headphone Connector		ø 3.5mm mini jack (Stereo)
Speakers		2W × 2 (Stereo speakers)
Maximum Screen Size		596.7mm W × 335.7mm H / 23.4" W × 13.2" H
Power Source		100-240VAC, 50/60Hz, 1.5A
Power Consumption* ¹		16W (Typical) Standby mode: 0.5W maximum, Off mode: 0.3W maximum
Dimensions / Net Weight		613.0 × 438.0 × 192.5mm / 24.1 × 17.2 × 7.5" (W×H×D) 4.0kg / 8.8lbs
Tilt Angle		Upward: 21.5 degrees Downward: 3.5 degrees
Environmental Considerations		Operating: Temperature 0 to 40°C / 32 to 104°F Humidity 20 to 80% (No condensation) Storage: Temperature -20 to 60°C / -4 to 140°F Humidity 10 to 90% (No condensation)
Approvals		CE, UKCA, TÜV-Bauart, EAC, VCCI, PSE, Eyesafe 2.0

NOTE *¹ When the USB devices are not connected.

*² Not available for G-MASTER G2770HS.

SPECIFICATIONS : G-MASTER GB2770QSU-B6 / W6

ENGLISH

Size Category		27"
LCD Panel	Panel technology	Fast IPS
	Size	Diagonal: 27.0" (68.6cm)
	Pixel pitch	0.233mm H × 0.233mm V
	Brightness	400cd/m ² (Typical), 180cd/m ² (Default / Energy Saving)
	Contrast ratio	1200 : 1 (Typical), Advanced Contrast Function Available
	Viewable angle	Right / Left: 89 degrees each, Up / Down: 89 degrees each (Typical)
	MPRT	0.2ms
Display Colors		Approx. 1.07G
Sync Frequency		HDMI: Horizontal: 30.0-217.4kHz, Vertical: 48-180Hz DisplayPort: Horizontal: 277.3kHz, Vertical: 48-180Hz
Native Resolution		2560 × 1440, 3.7 MegaPixels
Supported max. resolution		HDMI: 2560 × 1440, 144Hz DisplayPort: 2560 × 1440, 180Hz
Input Connector		HDMI × 1, DisplayPort × 1
Input Video Signal		HDMI, DisplayPort
USB Standard		USB3.2 Gen 1 (5Gbps, DC5V, 900mA)
Number of USB Ports Connector shape		1 Upstream: Series B 4 Downstream: Series A
Headphone Connector		ø 3.5mm mini jack (Stereo)
Speakers		2W × 2 (Stereo speakers)
Maximum Screen Size		596.7mm W × 335.7mm H / 23.4" W × 13.2" H
Power Source		100-240VAC, 50/60Hz, 1.5A
Power Consumption*		21W (Typical) Standby mode: 0.5W maximum, Off mode: 0.3W maximum
Dimensions / Net Weight		613.0 × 400.0 - 550.0 × 213.0mm / 24.1 × 15.7 - 21.9 × 8.3" (W×H×D) 5.4kg / 11.9lbs
Height Adjustment Range		150mm
Angle		Tilt: Upward: 23 degrees, Downward: 5 degrees Swivel: Left / Right: 45 degrees each Rotation: Clockwise / Counterclockwise: 90 degrees each
Environmental Considerations		Operating: Temperature 0 to 40°C / 32 to 104°F Humidity 20 to 80% (No condensation) Storage: Temperature -20 to 60°C / -4 to 140°F Humidity 10 to 90% (No condensation)
Approvals		CE, UKCA, TÜV-Bauart, EAC, VCCI, PSE, Eyesafe 2.0

NOTE * When the USB devices are not connected.

SPECIFICATIONS : G-MASTER G2770QSU-B6

Size Category		27"
LCD Panel	Panel technology	Fast IPS
	Size	Diagonal: 27.0" (68.6cm)
	Pixel pitch	0.233mm H × 0.233mm V
	Brightness	400cd/m ² (Typical), 180cd/m ² (Default / Energy Saving)
	Contrast ratio	1200 : 1 (Typical), Advanced Contrast Function Available
	Viewable angle	Right / Left: 89 degrees each, Up / Down: 89 degrees each (Typical)
	MPRT	0.2ms
Display Colors		Approx. 1.07G
Sync Frequency		HDMI: Horizontal: 30.0-217.4kHz, Vertical: 48-180Hz DisplayPort: Horizontal: 277.3kHz, Vertical: 48-180Hz
Native Resolution		2560 × 1440, 3.7 MegaPixels
Supported max. resolution		HDMI: 2560 × 1440, 144Hz DisplayPort: 2560 × 1440, 180Hz
Input Connector		HDMI × 1, DisplayPort × 1
Input Video Signal		HDMI, DisplayPort
USB Standard		USB3.2 Gen 1 (5Gbps, DC5V, 900mA)
Number of USB Ports Connector shape		1 Upstream: Series B 4 Downstream: Series A
Headphone Connector		∅ 3.5mm mini jack (Stereo)
Speakers		2W × 2 (Stereo speakers)
Maximum Screen Size		596.7mm W × 335.7mm H / 23.4" W × 13.2" H
Power Source		100-240VAC, 50/60Hz, 1.5A
Power Consumption*		21W (Typical) Standby mode: 0.5W maximum, Off mode: 0.3W maximum
Dimensions / Net Weight		613.0 × 438.0 × 192.5mm / 24.1 × 17.2 × 7.5" (W×H×D) 4.0kg / 8.8lbs
Tilt Angle		Upward: 21.5 degrees Downward: 3.5 degrees
Environmental Considerations		Operating: Temperature 0 to 40°C / 32 to 104°F Humidity 20 to 80% (No condensation) Storage: Temperature -20 to 60°C / -4 to 140°F Humidity 10 to 90% (No condensation)
Approvals		CE, UKCA, TÜV-Bauart, EAC, VCCI, PSE, Eyesafe 2.0

NOTE * When the USB devices are not connected.

DIMENSIONS : G-MASTER GB2470HSU

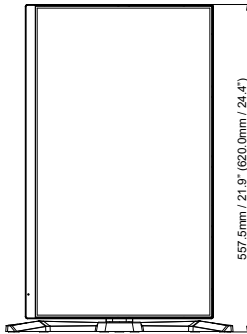
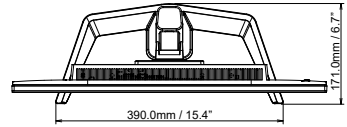
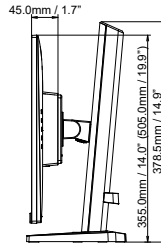
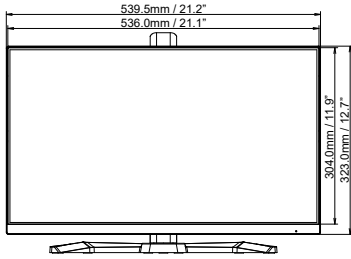

() : Maximum adjustment range

DIMENSIONS : G-MASTER G2470HSU / G2470HS

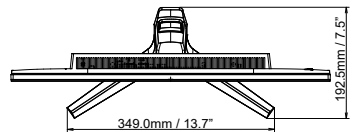
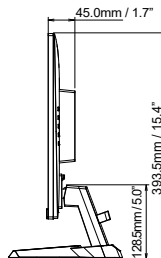
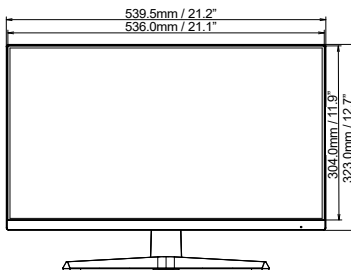

DIMENSIONS : G-MASTER GB2770HSU

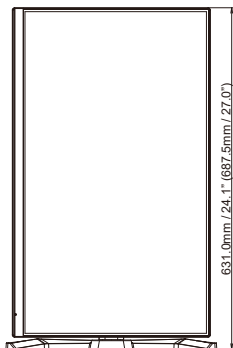
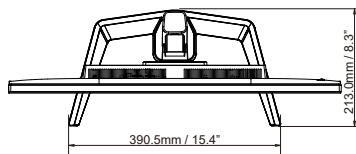
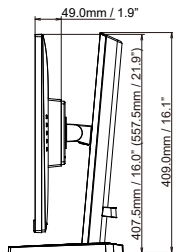
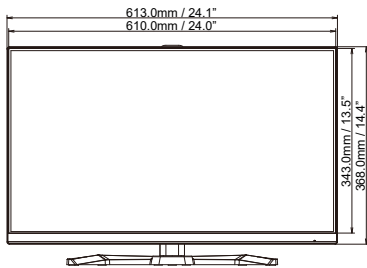

() : Maximum adjustment range

DIMENSIONS : G-MASTER G2770HSU / G2770HS

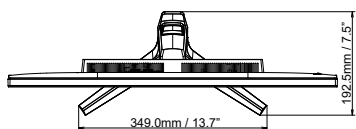
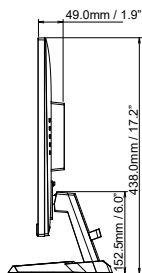
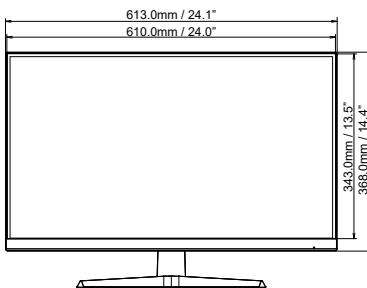

DIMENSIONS : G-MASTER GB2770QSU

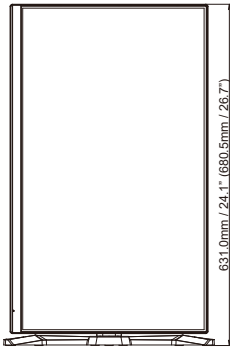
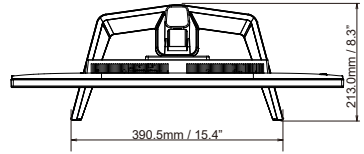
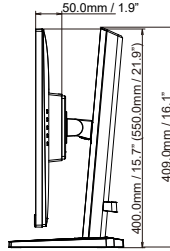
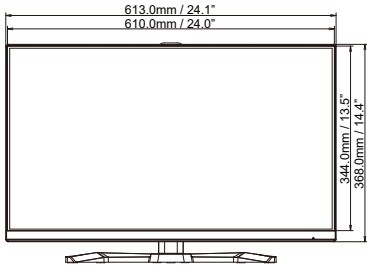

() : Maximum adjustment range

DIMENSIONS : G-MASTER G2770QSU

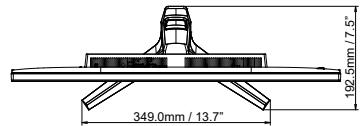
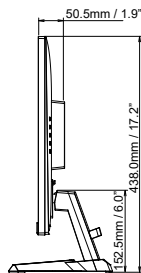
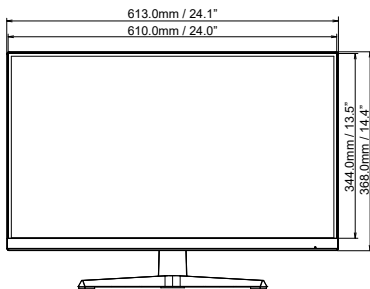

COMPLIANT TIMING

Video Mode	Horizontal Frequency	Vertical Frequency	Dot Clock
800 × 600	37.879kHz	60.317Hz	40.000MHz
	46.875kHz	75.000Hz	49.500MHz
1024 × 768	48.363kHz	60.004Hz	65.000MHz
	60.023kHz	75.029Hz	78.750MHz
1280 × 1024	63.981kHz	60.020Hz	108.000MHz
	79.976kHz	75.025Hz	135.000MHz
1680 × 1050	65.290kHz	60.000Hz	146.250MHz
1920 × 1080	67.500kHz	60.000Hz	148.500MHz
	135.000kHz	120.000Hz	297.000MHz
	166.587kHz	144.000Hz	346.500MHz
	192.778kHz	165.000Hz	401.000MHz
	200.520kHz	180.000Hz	417.000MHz
2560 × 1440	182.996kHz	120.000Hz	497.760MHz
	217.441kHz	144.000Hz	587.009MHz
	242.549kHz	165.000Hz	650.030MHz
	277.323kHz	180.000Hz	746.000MHz

NOTE *1 Only available for G-MASTER G(B)2770QSU.

*2 Only available for G-MASTER G(B)2770QSU with DisplayPort input.