

# USER MANUAL

# *ProLite*

## LCD Monitor

ENGLISH

A decorative graphic consisting of a grid of blue squares of varying sizes and opacities, arranged in a pattern that resembles a staircase or a series of steps. Some squares are solid blue, while others are outlined in blue.

*ProLite XUB2292HSU*  
*ProLite XUB2492HSU*  
*ProLite XUB2792HSU*  
*ProLite XU2292HSU*  
*ProLite XU2492HSU*  
*ProLite XU2792HSU*

Thank you very much for choosing the iiyama LCD monitor.

We recommend that you take a few minutes to read this comprehensive manual carefully before installing and switching on the monitor. Please keep this manual in a safe place for your future reference.



## Dear user, we congratulate you on the purchase of your iiyama LCD.

For details on warranty and locally used pixel policies that apply directly after installation of your product please check the iiyama website.

## To report a fault, please contact your local support centre found at <https://iiyama.com>

### Things to check before you call the iiyama information line

- | if the power cable is connected securely and turned on?
- | if the display has been turned on?
- | if the signal cable is connected securely and the correct input selected?
- | if the computer has been restarted with the display connected?
- | if the graphics card is correctly installed with the latest drivers possible?
- | if the correct native resolution has been selected via 'Display Properties'?
- | if the R/G/B signal configuration is correct?
- | if the displays On Screen Menu is shown?
- | if the correct brightness and contrast settings have been set?
- | if given display tolerances and compatibility have been considered?
- | if via the On Screen Menu you have performed a Factory Reset/Recall?

### Before reporting the screen defect, please prepare the following information/evidence:

- | model number \*
- | purchase receipt and serial number \*
- | name and address for collection
- | telephone/fax number, for availability during the day
- | convenient collection date (date, time)
- | short description of the defect

### Important Note:

If there is no fault found in the collected equipment after inspection, the transferring party shall incur charges for transport and administration.

If you have checked all of the above and there is still no picture, call our information line for assistance in your country.

\* see the identification plate on the back of the case.

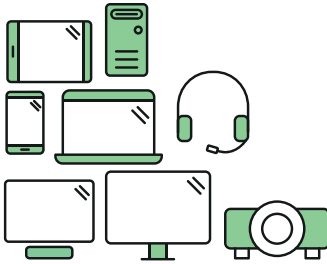

## Say hello to a more sustainable product

IT products are associated with a wide range of sustainability risks throughout their life cycle. Human rights violations are common in the factories. Harmful substances are used both in products and their manufacture. Products can often have a short lifespan because of poor ergonomics, low quality and when they are not able to be repaired or upgraded.

**This product is a better choice.** It meets all the criteria in TCO Certified, the world's most comprehensive sustainability certification for IT products. Thank you for making a responsible product choice, that help drive progress towards a more sustainable future!

Criteria in TCO Certified have a life-cycle perspective and balance environmental and social responsibility. Conformity is verified by independent and approved verifiers that specialize in IT products, social responsibility or other sustainability issues. Verification is done both before and after the certificate is issued, covering the entire validity period. The process also includes ensuring that corrective actions are implemented in all cases of factory non-conformities. And last but not least, to make sure that the certification and independent verification is accurate, both TCO Certified and the verifiers are reviewed regularly.

### Want to know more?

Read information about TCO Certified, full criteria documents, news and updates at [tcocertified.com](https://www.tcocertified.com). On the website you'll also find our Product Finder, which presents a complete, searchable listing of certified products.

## CE MARKING DECLARATION OF CONFORMITY

This LCD monitor complies with the requirements of the EC/EU Directive 2014/30/EU "EMC Directive", 2014/35/EU "Low Voltage Directive", 2009/125/EC "ErP Directive" and 2011/65/EU "RoHS Directive".

The electro-magnetic susceptibility has been chosen at a level that gives correct operation in residential areas, business and light industrial premises and small-scale enterprises, inside as well as outside of the buildings. All places of operation are characterised by their connection to the public low voltage power supply system.

IYAMA CORPORATION: Wijkemeerstraat 8, 2131 HA Hoofddorp, The Netherlands

Model No. : PL2792H / PL2492H / PL2292H



We recommend recycling of used product. Please contact your dealer or iiyama service center. Recycle information is obtained via the Internet, using the address: <https://iiyama.com>

You can access the Web page of different countries from there.

- We reserve the right to change specifications without notice.
- All trademarks used in this user manual are the property of their respective owners.
- Eprel registration number

XUB2292HSU-B6 : 1772302 XUB2292HSU-W6 : 1772303 XU2292HSU-B6 : 1772304  
XUB2492HSU-B6 : 1671415 XUB2492HSU-W6 : 1671438 XU2492HSU-B6 : 1671458  
XUB2792HSU-B6 : 1751409 XUB2792HSU-W6 : 1751479 XU2792HSU-B6 : 1751492

## TABLE OF CONTENTS

FOR YOUR SAFETY.....	1
SAFETY PRECAUTIONS.....	1
SPECIAL NOTES ON LCD MONITORS.....	3
CUSTOMER SERVICE.....	3
CLEANING.....	3
BEFORE YOU OPERATE THE MONITOR.....	4
FEATURES.....	4
CHECKING THE CONTENTS OF THE PACKAGE.....	4
INSTALLATION.....	5
FITTING AND REMOVAL OF BASE : ProLite XUB2792HSU / ProLite XUB2492HSU / ProLite XUB2292HSU.....	7
FITTING AND REMOVAL OF BASE : ProLite XU2792HSU / ProLite XU2492HSU / ProLite XU2292HSU.....	8
CONTROLS AND CONNECTORS : ProLite XUB2792HSU / ProLite XUB2492HSU / ProLite XUB2292HSU.....	9
CONTROLS AND CONNECTORS : ProLite XU2792HSU / ProLite XU2492HSU / ProLite XU2292HSU.....	10
CONNECTING YOUR MONITOR : ProLite XUB2792HSU / ProLite XUB2492HSU / ProLite XUB2292HSU.....	11
CONNECTING YOUR MONITOR : ProLite XU2792HSU / ProLite XU2492HSU / ProLite XU2292HSU.....	12
DISCONNECTING YOUR MONITOR.....	13
COMPUTER SETTING.....	13
ADJUSTING THE HEIGHT AND THE VIEWING ANGLER : ProLite XUB2792HSU / ProLite XUB2492HSU / ProLite XUB2292HSU...	13
ADJUSTING THE VIEWING ANGLE : ProLite XU2792HSU / ProLite XU2492HSU / ProLite XU2292HSU.....	14
OPERATING THE MONITOR.....	15
ADJUSTMENT MENU CONTENTS.....	16
STANDBY FEATURE.....	25
TROUBLE SHOOTING.....	26
RECYCLING INFORMATION.....	27

APPENDIX .....	28
SPECIFICATIONS : ProLite XUB2792HSU-B6 / W6 .....	28
SPECIFICATIONS : ProLite XU2792HSU-B6 .....	29
SPECIFICATIONS : ProLite XUB2492HSU-B6 / W6 .....	30
SPECIFICATIONS : ProLite XU2492HSU-B6 .....	31
SPECIFICATIONS : ProLite XUB2292HSU-B6 / W6 .....	32
SPECIFICATIONS : ProLite XU2292HSU-B6 .....	33
DIMENSIONS : ProLite XUB2792HSU .....	34
DIMENSIONS : ProLite XU2792HSU.....	34
DIMENSIONS : ProLite XUB2492HSU .....	35
DIMENSIONS : ProLite XU2492HSU.....	35
DIMENSIONS : ProLite XUB2292HSU .....	36
DIMENSIONS : ProLite XU2292HSU.....	36
COMPLIANT TIMING .....	37

# FOR YOUR SAFETY

## SAFETY PRECAUTIONS

### WARNING

#### **STOP OPERATING THE MONITOR WHEN YOU SENSE TROUBLE**

If you notice any abnormal phenomena such as smoke, strange sounds or fumes, unplug the monitor and contact your dealer or iiyama service center immediately. Further use may be dangerous and can cause fire or electric shock.

#### **NEVER REMOVE THE CABINET**

High voltage circuits are inside the monitor. Removing the cabinet may expose you to the danger of fire or electric shock.

#### **DO NOT PUT ANY OBJECT INTO THE MONITOR**

Do not put any solid objects or liquids such as water into the monitor. In case of an accident, unplug your monitor immediately and contact your dealer or iiyama service center. Using the monitor with any object inside may cause fire, electric shock or damage.

#### **INSTALL THE MONITOR ON A FLAT, STABLE SURFACE**

The monitor may cause an injury if it falls or is dropped.

#### **DO NOT USE THE MONITOR NEAR WATER**

Do not use where water may be splashed or spilt onto the monitor as it may cause fire or electric shock.

#### **OPERATE UNDER THE SPECIFIED POWER SUPPLY**

Be sure to operate the monitor only with the specified power supply. Use of an incorrect voltage will cause malfunction and may cause fire or electric shock.

#### **PROTECT THE CABLES**

Do not pull or bend the power cable and signal cable. Do not place the monitor or any other heavy objects on the cables. If damaged, the cables may cause fire or electric shock.

#### **ADVERSE WEATHER CONDITIONS**

It is advisable not to operate the monitor during a heavy thunder storm as the continual breaks in power may cause malfunction. It is also advised not to touch the plug in these circumstances as it may cause electric shock.

## CAUTION

### INSTALLATION LOCATION

Do not install the monitor where sudden temperature changes may occur, or in humid, dusty or smoky areas as it may cause fire, electric shock or damage. You should also avoid areas where the sun shines directly on the monitor.

### DO NOT PLACE THE MONITOR IN A HAZARDOUS POSITION

The monitor may topple and cause injury if not suitably located. Please also ensure that you do not place any heavy objects on the monitor, and that all cables are routed such that children may not pull the cables and possibly cause injury.

### MAINTAIN GOOD VENTILATION

Ventilation slots are provided to keep the monitor from overheating. Covering the slots may cause fire. To allow adequate air circulation, place the monitor at least 10cm (or 4 inches) from any walls.

When removing the tilt stand, the ventilation slots on the back side of the monitor can be blocked. This may overheat the monitor and may cause fire or damage. Make sure to allow enough ventilation when removing the tilt stand. Operating the monitor on its back, side, upside down or on a carpet or any other soft material may also cause damage.

### DISCONNECT THE CABLES WHEN YOU MOVE THE MONITOR

When you move the monitor, turn off the power switch, unplug the monitor and be sure the signal cable is disconnected. If you do not disconnect them, it may cause fire or electric shock.

### UNPLUG THE MONITOR

If the monitor is not in use for a long period of time it is recommended that it is left unplugged to avoid accidents.

### HOLD THE PLUG WHEN DISCONNECTING

To disconnect the power cable or signal cable, always pull it by the plug. Never pull on the cable itself as this may cause fire or electric shock.

### DO NOT TOUCH THE PLUG WITH WET HANDS

Pulling or inserting the plug with wet hands may cause electric shock.

### WHEN YOU INSTALL THE MONITOR ON YOUR COMPUTER

Be sure the computer is strong enough to hold the weight of the monitor, otherwise, you may damage your computer.

### CAREFUL! PROTECT YOUR HANDS AND FINGERS

- Be careful not to hurt your fingers or hands when you change the height or the angle.
- Injury can occur if care is not taken to avoid finger contact with the displays base when adjusting the height. (Just for height adjustable model.)

### REMARK FOR 24/7 USAGE

This product is not specifically designed for 24/7 usage in all environments.

### REMARK FOR WALL MOUNTING

This product is not designed for digital signage (electronic signboard) applications such as wall mounting.

## OTHERS

### ERGONOMIC RECOMMENDATIONS

To eliminate eye fatigue, do not operate the monitor against a bright background or in a dark room. For optimal viewing comfort, the monitor should be just below eye level and 40-60 cm (16-24 inches) away from your eyes. When using the monitor over a prolonged time, a ten minute break every hour is recommended as looking at the screen continuously can cause eye strain.



## SPECIAL NOTES ON LCD MONITORS

The following symptoms are normal with LCD monitors and do not indicate a problem.

### NOTE

- When you first turn on the LCD monitor, the picture may not fit in the display area because of the type of computer that is used. In this case, adjust the picture position to the correct position.
- You may find slightly uneven brightness on the screen depending on the desktop pattern you use.
- Due to the nature of the LCD screen, an afterimage of the previous screen may remain after switching the image, when the same image is displayed for hours. In this case, the screen can be recovered slowly by changing the image or turning off the Power Switch for some hours.

## CUSTOMER SERVICE

### NOTE

- If you have to return your unit for service and the original packaging has been discarded, please contact your dealer or iiyama service center for advice or replacement packaging.

## CLEANING

### WARNING

- If you drop any materials or liquids such as water into the monitor when cleaning, unplug the power cable immediately and contact your dealer or iiyama service center.

### CAUTION

- For safety reasons, turn off the power switch and unplug the monitor before you clean it.

### NOTE

- To protect the LCD panel, do not scratch or rub the screen with a hard object.
- Never use any of the following strong solvents. These will damage the cabinet and the LCD screen.

Thinner	Spray-type cleaner
Benzine	Wax
Abrasive cleaner	Acid or Alkaline solvent

- Touching the cabinet with any product made from rubber or plastic for a long time may cause degeneration or loss of paint on the cabinet.

### CABINET

Stains can be removed with a cloth lightly moistened with a mild detergent solvent. Then wipe the cabinet with a soft dry cloth.

### LCD SCREEN

Periodic cleaning with a soft dry cloth is recommended.

Don't use tissue paper etc. because these will damage the LCD screen.

# BEFORE YOU OPERATE THE MONITOR

## FEATURES

- ◆ Supports Resolutions up to 1920 × 1080
- ◆ High Contrast 1000:1 (Typical), Adv. Contrast Function Available / Brightness 250cd/m<sup>2</sup> (Typical) : ProLite XUB2292HSU / ProLite XU2292HSU
- ◆ High Contrast 1300:1 (Typical), Adv. Contrast Function Available / Brightness 250cd/m<sup>2</sup> (Typical) : ProLite XUB2492HSU / ProLite XU2492HSU / ProLite XUB2792HSU / ProLite XU2792HSU
- ◆ Moving Picture Response Time 0.4ms
- ◆ Supports AMD FreeSync™ technology
- ◆ Blue Light Reducer
- ◆ Flicker Free
- ◆ Digital Character Smoothing
- ◆ 2 × 2W Stereo Speakers
- ◆ Standby Feature
- ◆ VESA Mounting Standard (100mm×100mm) Compliant
- ◆ Keyhole for Security Lock

## CHECKING THE CONTENTS OF THE PACKAGE

The following accessories are included in your package. Check to see if they are enclosed with the monitor. If anything is missing or damaged, please contact your local iiyama dealer or regional iiyama office.

- |                             |                             |   |
|-----------------------------|-----------------------------|---|
| ■ Power Cable* <sup>1</sup> | ■ HDMI Cable                | ■ DisplayPort Cable* <sup>4</sup>       |
| ■ USB Cable                 | ■ Stand-Neck                | ■ Stand-Base with a screw* <sup>2</sup> |
| ■ Stand-Base* <sup>3</sup>  | ■ Screwdriver* <sup>2</sup> | ■ Safety Guide                          |
| ■ Quick Start Guide         |                             |   |

### CAUTION

\*<sup>1</sup> The rating of the Power Cable enclosed in 120V area is 10A/125V. If you are using a power supply higher than this rating, then a power cable with a rating of 10A/250V must be used. However, all guarantees and warranties are void for any problems or damage caused by a power cable not supplied by iiyama.

An approved power cable greater or equal to H05VVF, 3G, 0.75mm<sup>2</sup> must be used.

\*<sup>2</sup> Accessory for ProLite XUB2792HSU / ProLite XUB2492HSU / ProLite XUB2292HSU

\*<sup>3</sup> Accessory for ProLite XU2792HSU / ProLite XU2492HSU / ProLite XU2292HSU

\*<sup>4</sup> Accessory for ProLite XUB2792HSU / ProLite XU2792HSU / ProLite XUB2492HSU / ProLite XU2492HSU

## INSTALLATION

### CAUTION

- Before installation, make sure the display arm or desk arm stand is strong enough to hold the necessary weight of the monitor and the mount.
- Panel angle adjustment range : 22° upward and 5° downward

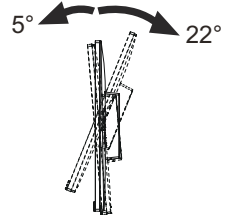

### [DISPLAY ARM OR DESK ARM STAND]

### CAUTION

- When you use with the display arm or desk arm stand, in consideration of thickness of the mounting stage, tighten the M4 Screws (4pcs) which "L" length is 7mm to fasten the monitor. Using the screw longer than this may cause electric shock or damage because it may contact with the electrical parts inside the monitor.

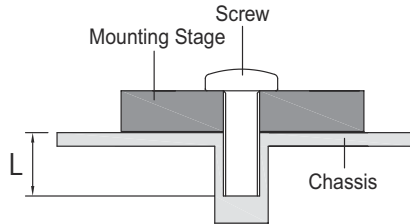

## [ROTATING THE MONITOR]

### • ProLite XUB2792HSU / ProLite XUB2492HSU / ProLite XUB2292HSU

The monitor is designed to be compatible with both landscape and portrait modes. Video card for portrait display will be required for rotating the image on the screen.

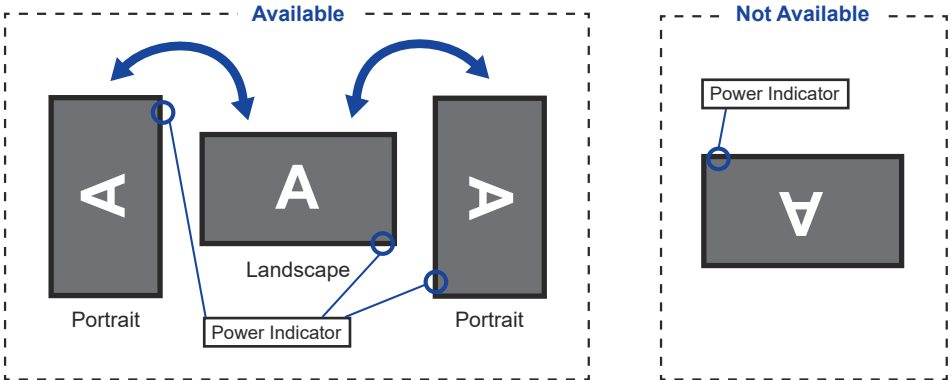

### With Stand:

#### NOTE

- Adjust the monitor's height before panel rotation.
- Attempting to rotate the panel forcibly without adjusting the stand height may cause damage to the panel or the stand.

### • ProLite XU2792HSU / ProLite XU2492HSU / ProLite XU2292HSU

The monitor is designed to be compatible only with the landscape mode.

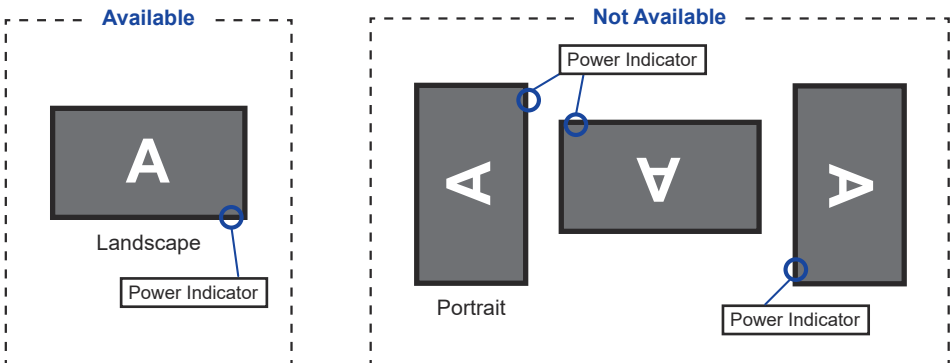

## FITTING AND REMOVAL OF BASE :

ProLite XUB2792HSU / ProLite XUB2492HSU / ProLite XUB2292HSU

### CAUTION

- Put the monitor on a stable surface. The monitor may cause injury or damage if it falls or is dropped.
- Do not give a strong impact to the monitor. It may cause damage.
- Unplug the monitor before removal or installation to avoid an electric shock or a damage.

### <Installation>

- ① Put a piece of soft cloth on the table beforehand to prevent the monitor from being scratched. Lay the monitor flat on a table with front face down.
- ② Install the Stand-Neck to the monitor and then tighten the 'thumb screw' with the provided screwdriver to secure them.

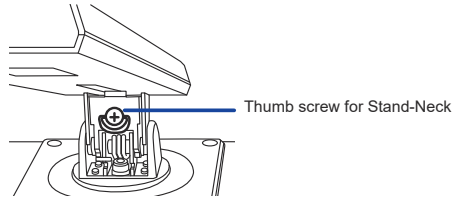
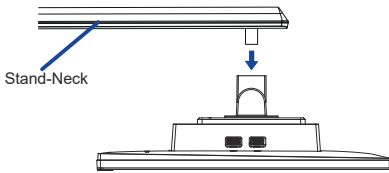

- ③ Install the Stand-Base to the Stand-Neck and then tighten the 'thumb screw' to secure them.

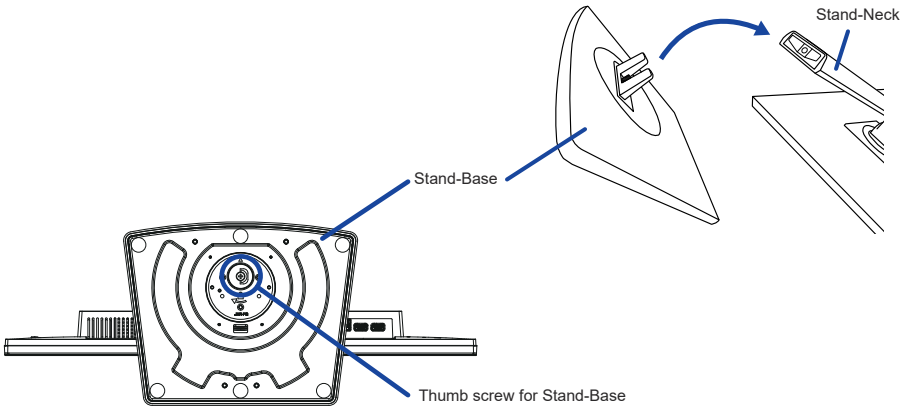

### <Removal>

- ① Put a piece of soft cloth on the table beforehand to prevent the monitor from being scratched. Lay the monitor flat on a table with front face down.
- ② Loosen the 'thumb screw' to remove the Stand-Base from the Stand-Neck.
- ③ Loosen the 'thumb screw' with the provided screwdriver to remove the Stand-Neck from the monitor.

## FITTING AND REMOVAL OF BASE :

### ProLite XU2792HSU / ProLite XU2492HSU / ProLite XU2292HSU

- CAUTION**
- Put the monitor on a stable surface. The monitor may cause injury or damage if it falls or is dropped.
  - Do not give a strong impact to the monitor. It may cause damage.
  - Unplug the monitor before removal or installation to avoid an electric shock or a damage.

#### <Installation>

- ① Put a piece of soft cloth on the table beforehand to prevent the monitor from being scratched. Lay the monitor flat on a table with front face down.
- ② Hold the monitor and install the Stand-Neck to the monitor until it clicks to secure.
- ③ Install the Stand-Base to the Stand-Neck.

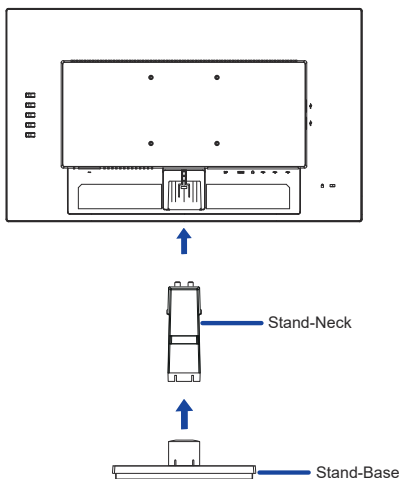

#### <Removal>

- ① Put a piece of soft cloth on the table beforehand to prevent the monitor from being scratched. Lay the monitor flat on a table with front face down.
- ② Keep pressing the Hooks inward to pull out the Stand-Base.
- ③ Press the Hook on the back of the monitor and remove the Stand-Neck from the monitor.
- ④ Pull and hold the Cable Holder toward you, slide it to the left and remove it.

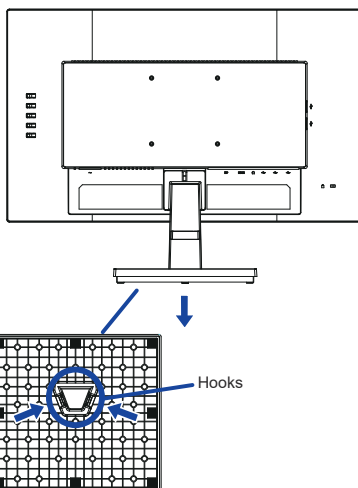
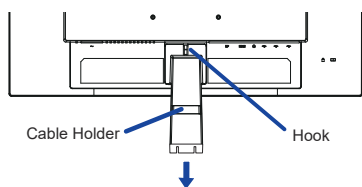

# CONTROLS AND CONNECTORS :

## ProLite XUB2792HSU / ProLite XUB2492HSU / ProLite XUB2292HSU

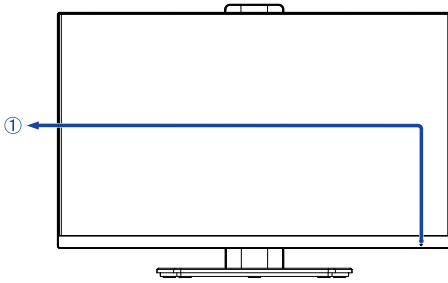

<Front>

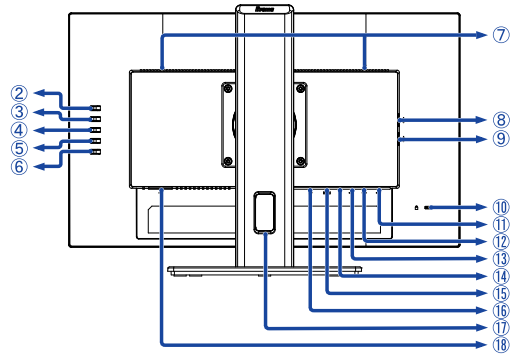

<Back>

ENGLISH

- ① Power Indicator

**NOTE** Blue: Normal operation  
Orange: Standby mode

- ② Signal Select / Exit Button (INPUT) \*
- ③ + / Volume Button ( + ) \*
- ④ - / Eco Button ( - ) \*
- ⑤ Menu Button (MENU)
- ⑥ Power Switch (⏻)
- ⑦ Speakers

- ⑧ USB Downstream Connector ( USB3.2 Gen 1: 5Gbps, 5V, 900mA)
- ⑨ USB Downstream Connector ( USB3.2 Gen 1: 5Gbps, 5V, 900mA)
- ⑩ Keyhole for Security Lock

**NOTE** You can fasten a security lock and cable to prevent the monitor from being removed without your permission.

- ⑪ USB Downstream Connector ( USB3.2 Gen 1: 5Gbps, 5V, 900mA)
- ⑫ USB Downstream Connector ( USB3.2 Gen 1: 5Gbps, 5V, 900mA)
- ⑬ USB Upstream Connector ( USB3.2 Gen 1: 5Gbps, 5V, 900mA)
- ⑭ Headphone Connector ( )
- ⑮ HDMI Connector (HDMI)
- ⑯ DisplayPort Connector (DP)
- ⑰ Cable Hole
- ⑱ AC Connector ( ~ : Alternating current)

\* You can skip the Menu items and directly display an option setting screen or an adjustment scale.

# CONTROLS AND CONNECTORS :

## ProLite XU2792HSU / ProLite XU2492HSU / ProLite XU2292HSU

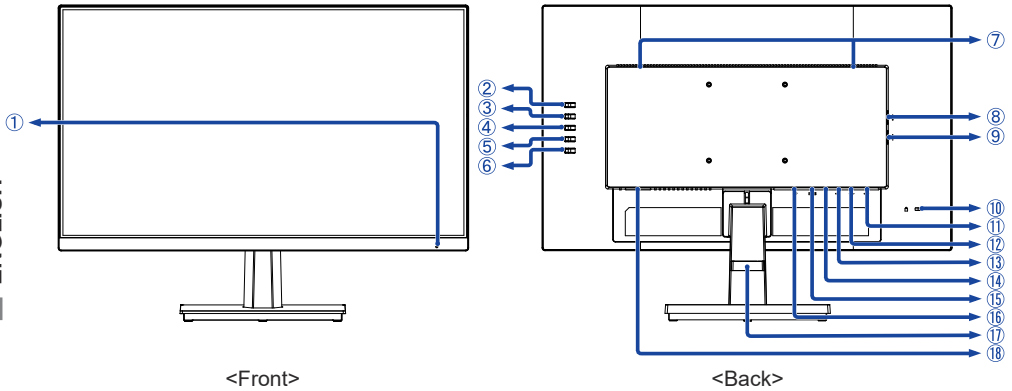

- ① Power Indicator

**NOTE** Blue: Normal operation  
Orange: Standby mode

- ② Signal Select / Exit Button (INPUT) \*
- ③ + / Volume Button ( + ) \*
- ④ - / Eco Button ( - ) \*
- ⑤ Menu Button (MENU)
- ⑥ Power Switch (⏻)

- ⑦ Speakers

- ⑧ USB Downstream Connector ( USB3.2 Gen 1: 5Gbps, 5V, 900mA)

- ⑨ USB Downstream Connector ( USB3.2 Gen 1: 5Gbps, 5V, 900mA)

- ⑩ Keyhole for Security Lock

**NOTE** You can fasten a security lock and cable to prevent the monitor from being removed without your permission.

- ⑪ USB Downstream Connector ( USB3.2 Gen 1: 5Gbps, 5V, 900mA)

- ⑫ USB Downstream Connector ( USB3.2 Gen 1: 5Gbps, 5V, 900mA)

- ⑬ USB Upstream Connector ( )

- ⑭ Headphone Connector ( )

- ⑮ HDMI Connector (HDMI)

- ⑯ DisplayPort Connector (DP)

- ⑰ Cable Holder

- ⑱ AC Connector ( ~ : Alternating current)

\* You can skip the Menu items and directly display an option setting screen or an adjustment scale.



## CONNECTING YOUR MONITOR : ProLite XUB2792HSU / ProLite XUB2492HSU / ProLite XUB2292HSU

- ① Ensure that both the computer and the monitor are switched off.
- ② Connect the computer to the monitor with the signal cable.
- ③ Connect the computer to the monitor with the USB Cable.
- ④ Connect the Power Cable to the monitor first and then to the power source.
- ⑤ Turn on your monitor and computer.

- NOTE**
- Make sure that the building installation has a circuit breaker of 120/240V, 20A (maximum).
  - The signal cables used for connecting the computer and monitor may vary with the type of computer used. An incorrect connection may cause serious damage to both the monitor and the computer. The cable supplied with the monitor is for a standard connector. If a special cable is required please contact your local iiyama dealer or regional iiyama office.
  - Make sure you tighten the finger screws at each end of the signal cable.
  - The Class I pluggable equipment Type A must be connected to protective earth.
  - The socket-outlet shall be installed near the equipment and shall be easily accessible.
  - Excessive sound pressure from ear-/headphones can cause hearing damage/hearing loss.

[Example of Connection]

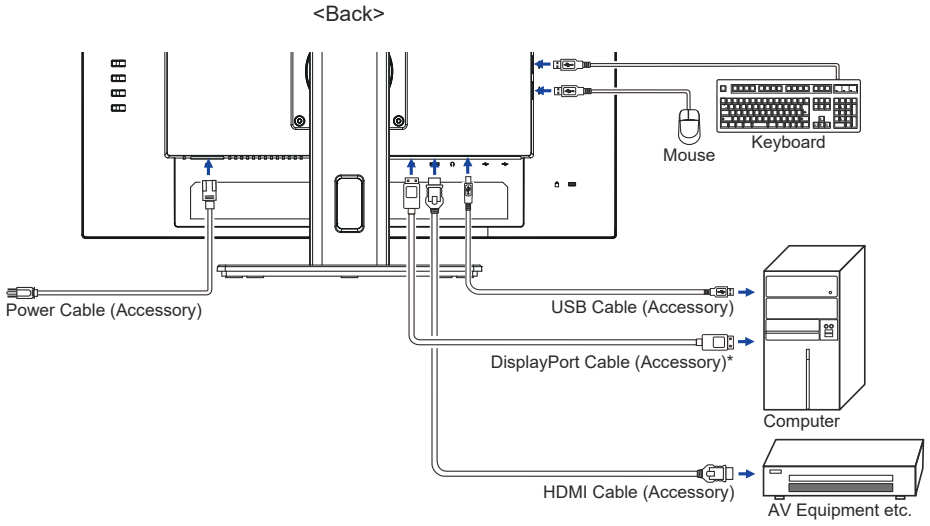

\* Accessory for ProLite XUB2792HSU / ProLite XUB2492HSU only.

### [ Collect Cables ]

Put the cables through the cable hole to bundle them.

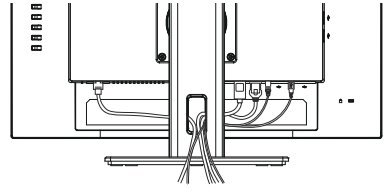

## CONNECTING YOUR MONITOR : ProLite XU2792HSU / ProLite XU2492HSU / ProLite XU2292HSU

- ① Ensure that both the computer and the monitor are switched off.
- ② Connect the computer to the monitor with the signal cable.
- ③ Connect the computer to the monitor with the USB Cable.
- ④ Connect the Power Cable to the monitor first and then to the power source.
- ⑤ Turn on your monitor and computer.

### NOTE

- Make sure that the building installation has a circuit breaker of 120/240V, 20A (maximum).
- The signal cables used for connecting the computer and monitor may vary with the type of computer used. An incorrect connection may cause serious damage to both the monitor and the computer. The cable supplied with the monitor is for a standard connector. If a special cable is required please contact your local iiyama dealer or regional iiyama office.
- Make sure you tighten the finger screws at each end of the signal cable.
- The Class I pluggable equipment Type A must be connected to protective earth.
- The socket-outlet shall be installed near the equipment and shall be easily accessible.
- Excessive sound pressure from ear-/headphones can cause hearing damage/hearing loss.

[Example of Connection]

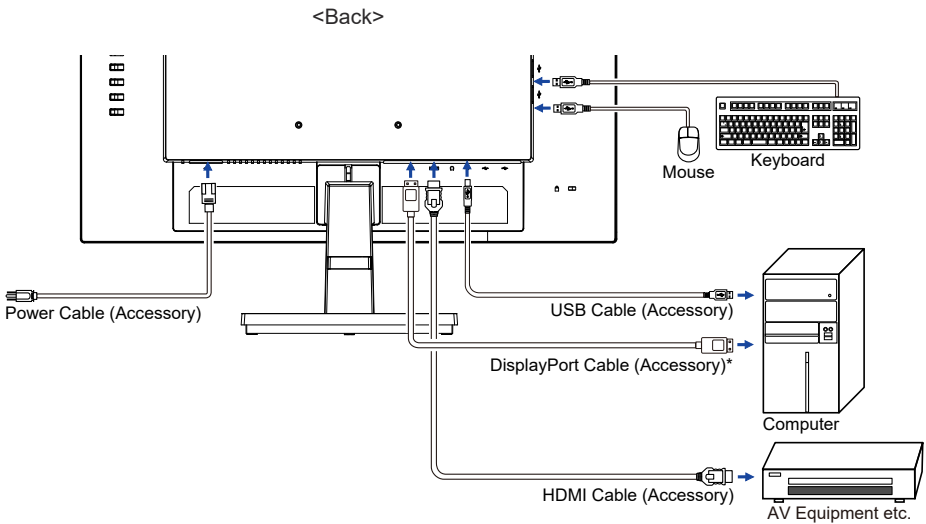

\* Accessory for **ProLite XU2792HSU / ProLite XU2492HSU** only.

### [ Collect Cables ]

Put the cables through the Cable Holder to bundle them.

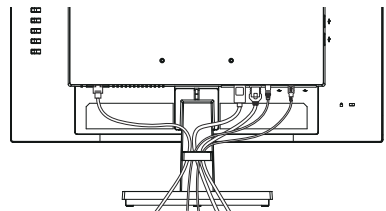

## DISCONNECTING YOUR MONITOR

- ① Ensure that both the computer and the monitor are switched off.
- ② Disconnect the power source first and then the Power Cable from the monitor.
- ③ Disconnect the USB cable from the computer and the monitor.
- ④ Disconnect the signal cable from the computer and the monitor.

## COMPUTER SETTING

- Signal Timing  
Change to the desired signal timing listed on page 37: COMPLIANT TIMING.

## ADJUSTING THE HEIGHT AND THE VIEWING ANGLE : ProLite XUB2792HSU / ProLite XUB2492HSU / ProLite XUB2292HSU

- For optimal viewing it is recommended to position yourself directly opposite to the full face of the monitor, then adjust the monitor's height and angle to your own preference.
- Hold the panel so that the monitor does not topple when you change the monitor's height or angle.
- You are able to adjust the monitor's height up to 150mm, angle up to 45° right and left, 22° upward and 5° downward.

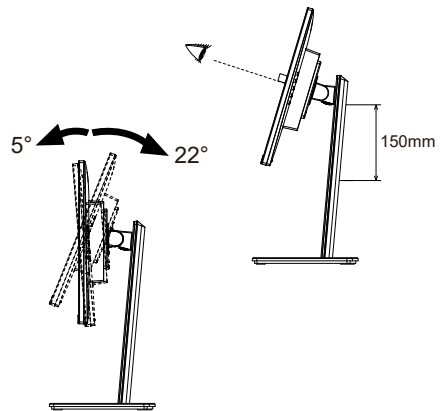

- NOTE**
- Do not touch the LCD screen when you change the height or the angle. It may cause damage or break the LCD screen.
  - Careful attention is required not to pinch your fingers or hands into the moving part of the stand when you change the angle.
  - Injury can occur if care is not taken to avoid finger contact with the displays base when adjusting the height.

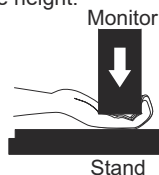
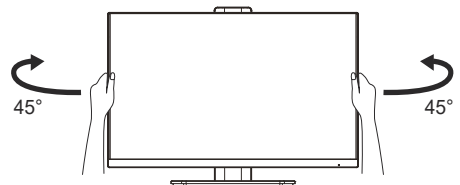

## ADJUSTING THE VIEWING ANGLE : ProLite XU2792HSU / ProLite XU2492HSU / ProLite XU2292HSU

- For optimal viewing it is recommended to look at the full face of the monitor.
- Hold the stand so that the monitor does not topple when you change the monitor's angle.
- You are able to adjust the monitor's angle up to 21.5° upward, 3.5° downward.
- In order to ensure a healthy and relaxed body position when using the monitor at visual display workstations, it is recommended that the adjusted tilt angle should not exceed 10°. Adjust the monitor's angle to your own preference.

### NOTE

- Do not touch the LCD screen when you change the angle. It may cause damage or break the LCD screen.
- Careful attention is required not to catch your fingers or hands when you change the angle.

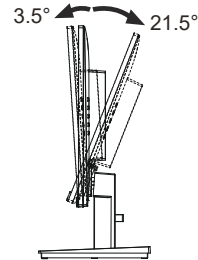
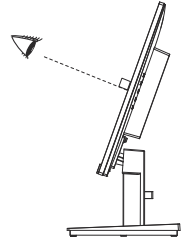

# OPERATING THE MONITOR

To create the best picture, your iiyama LCD monitor has been preset at the factory with the COMPLIANT TIMING shown on page 37. You are also able to adjust the picture by following the button operation shown below.

- ① Press the MENU Button to start the On Screen Display feature. There are additional Menu items which can be switched by using the + / - Buttons.

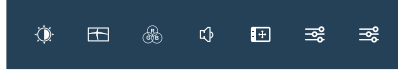

- ② Select the Menu item which contains the adjustment icon relating to the adjustment you want to make. Press the MENU Button. Then, use the + / - Buttons to highlight the desired adjustment icon.
- ③ Press the MENU Button again. Use the + / - Buttons to make the appropriate adjustment or setting.
- ④ Press the INPUT Button to leave the menu, and the settings you just made would be automatically saved.

For example, to correct for OSD vertical position, select "OSD SETTINGS" of Menu item and then press the MENU Button. Then, select "OSD Vertical Position" by using the + / - Buttons. An adjustment page appears after you press the MENU Button.

Then, use the + / - Buttons to change the OSD vertical position settings. The OSD vertical position should be changing accordingly while you are doing this.

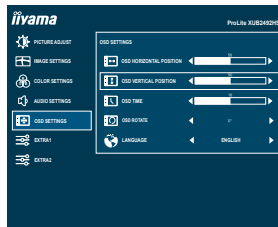

Press the INPUT Button lastly, it ends, all changes are saved in the memory.

## NOTE

- When button operations are aborted during adjustment, On-Screen Display disappears when the time set for the OSD Time has passed. Also, the INPUT button can be used to return previous menu and turn off the On-Screen Display.
- Any changes are automatically saved in the memory when the On Screen Display disappears. Turning off the power should be avoided while using the Menu.

# ADJUSTMENT MENU CONTENTS

## Picture Adjust

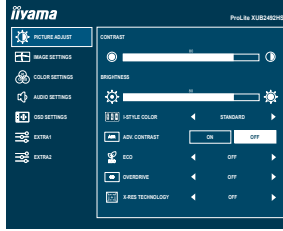

Adjustment Item	Problem / Option		Button to Press
Contrast *1	Too dull Too intense		+ -
Brightness *1,2	Too dark Too bright		+ -
i-Style Color *1,2,3	Off	Return to a state set by color adjustment except i-Style Color.	
	Standard	For general windows environment and monitor default setting	
	Text	For text editing and viewing in a word processing environment	
	Internet	For internet environment	
	Game	For PC game environment	
	Movie	For movie and video environment	
	Sports	For sport environment	
Adv. Contrast *1	On	Increased Contrast Ratio	
	Off	Typical Contrast Ratio	
Eco *1	<b>Direct</b>	Off	Normal
		Mode1	Brightness of back-light is reduced.
		Mode2	Brightness of back-light is reduced more than Mode1.
		Mode3	Brightness of back-light is reduced more than Mode2.

**NOTE** Adv. Contrast adjusts brightness according to the image, and improve the contrast ratio during movie playing.  
 Contrast, Brightness, i-Style Color, Eco, Gamma and Color Temp. cannot be adjusted and selected while Adv. Contrast is active.

### Direct



You can skip the Menu items and directly display an option setting screen by using the following button operations.

- Eco: Press the – Button when the Menu is not displayed.

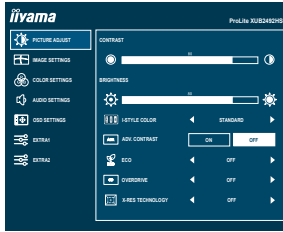

## Picture Adjust



Adjustment Item	Problem / Option		Button to Press
Overdrive *4	Off / 1 / 2 / 3 / 4 / 5 It will improve the gray level response time of the LCD panel. A higher level results in a faster response time.		  
X-Res Technology	Off	Normal	
	Soft	Enhance the picture edge.	
	Middle	Enhance the picture edge more than the Soft option.	
	Hard	Enhance the picture edge more than the Middle option.	

\*1 The availability of each item depends on which item is activated. See page 24 Function Correlation Matrix for more details.





\*2 Adjust the Brightness when you are using the monitor in a dark room and feel the screen is too bright.

\*3 i-Style Color is disabled when Blue Light Reducer is activated.

\*4 When Overdrive is activated, some level of image retention will be caused.

 Image Settings



Adjustment Item	Problem / Option		Button to Press
Blue Light Reducer *1	Off	Typical	
	Mode 1	Blue light is reduced.	
	Mode 2	Blue light is reduced more than Mode 1.	
	Mode 3	Blue light is reduced more than Mode 2.	
Sharp and Soft	1 2 3 4 5 6 You can change the picture quality from 1 to 6 (sharp to soft). Press the + Button to change the picture quality in numerical order. Press the – Button to change the picture quality in reverse numerical order.		   
Video Mode Adjust *2,3	Full	Expansion display	
	Aspect	Expansion display of Aspect	

\*1 The availability of each item depends on which item is activated. See page 24 Function Correlation Matrix for more details.

\*2 It can display in the center of the screen with a 4:3, 5:4 or 16:10 aspect ratio when input video resolution is 4:3, 5:4 or 16:10.









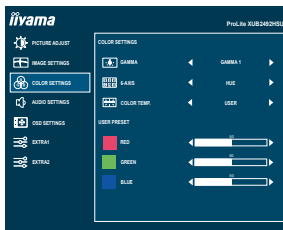



\*3 Disabled when “FreeSync” is activated.





## Color Settings



Adjustment Item	Problem / Option		Button to Press	
Gamma * <sup>1</sup>	Gamma1	Normal		
	Gamma2	Dark		
	Gamma3	High contrast		
6-Axis * <sup>1,2</sup>	Hue	Red	Too weak Too strong	   
		Yellow		
		Green		
		Cyan		
		Blue		
		Magenta		
	Saturation	Red	Too weak Too strong	   
		Yellow		
		Green		
		Cyan		
		Blue		
		Magenta		
Color Temp. * <sup>2,3</sup>	User	Red	Too weak Too strong	   
		Green		
		Blue		
	Warm	Warm color		
	Normal	Normal color		
	Cool	Cool color		

\*<sup>1</sup> Disabled when “i-Style Color” is activated.

\*<sup>2</sup> Disabled when “Blue Light Reducer” is activated.

\*<sup>3</sup> Disabled when “Adv. Contrast” is activated.



## Audio Settings

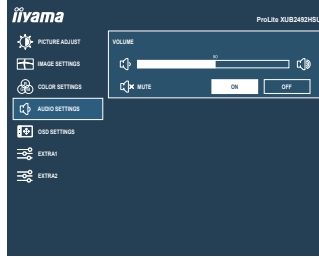

Adjustment Item	Problem / Option	Button to Press
Volume <b>Direct</b>	Too soft Too loud	<b>+</b> <b>-</b>
Mute	On	Turn off the sound temporarily.
	Off	Return the sound volume to the previous level.

**NOTE** Press the + Button to display the volume adjustment bar and switch On and Off the Mute function by pressing the + / – Buttons.

### Direct

You can skip the Menu items and directly display an adjustment scale by using the following button operations.

- Volume : Press the + Button when the Menu is not displayed.

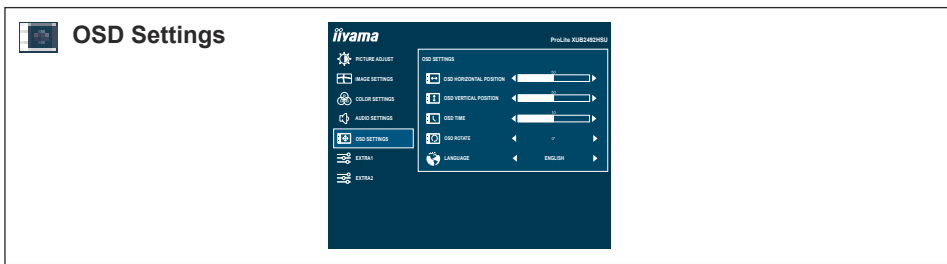

Adjustment Item	Problem / Option	Button to Press		
OSD Horizontal Position	OSD is too left OSD is too right	<input type="button" value="+"/> <input type="button" value="-"/>		
OSD Vertical Position	OSD is too low OSD is too high	<input type="button" value="+"/> <input type="button" value="-"/>		
OSD Time	You can set the OSD display duration time between 5 and 60 seconds.	<input type="button" value="+"/> <input type="button" value="-"/>		
OSD Rotate *	Rotates the OSD. 0° (Normal) / +90° (Rotate right) / -90° (Rotate left)	<input type="button" value="+"/> <input type="button" value="-"/>		
Language	English	English	Nederlands	Dutch
	Deutsch	German	Polski	Polish
	Español	Spanish	Português	Portuguese
	Français	French	Русский	Russian
	Italiano	Italian	Česky	Czech
	日本語	Japanese		

\* For ProLite XUB2292HSU, XUB2492HSU, XUB2792HSU

## Extra1



Adjustment Item	Problem / Option	
MBR <sup>*1,2</sup>	Off / 1 / 2 / 3 / 4 / 5 / 6 / 7 Reduces motion blur on the LCD panel. <div style="float: right;">  <input data-bbox="954 379 1005 411" type="button" value="+"/>  <input data-bbox="954 411 1005 443" type="button" value="-"/> </div>	
FreeSync <sup>*2</sup>	On	Activates the FreeSync function.
	Off	The FreeSync function is turned off.
USB BC	On	USB devices can be charged even when the monitor is not connected to a working computer with the included USB cable.
	Off	USB devices cannot be charged when the monitor is not connected to a working computer with the included USB cable.
<b>NOTE</b> When the monitor is turned off, USB devices cannot be charged even when the USB BC function is on.		

<sup>\*1</sup> Disabled when “FreeSync” is activated. Available when the refresh rate is 75Hz or higher. 100Hz is recommended.

<sup>\*2</sup> The availability of each item depends on which item is activated. See page 24 Function Correlation Matrix for more details.



## Extra2

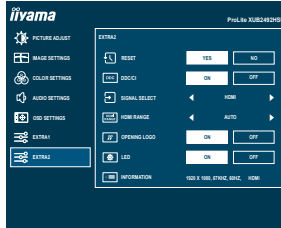

Adjustment Item	Problem / Option	
Reset	Yes	Factory-preset data is restored.
	No	Return to Menu.
DDC/CI	On	DDC/CI is On.
	Off	DDC/CI is Off.
Signal Select <b>Direct</b>	Auto	Select the signal input automatically.
	HDMI	Select the Digital (HDMI) input.
	DP	Select the Digital (DisplayPort) input.
<b>NOTE</b> If "Auto" is selected, only one source available is selected automatically. If there are more input sources available and you select one of them, the "Auto" option is not available. If multiple inputs are connected, the monitor may not recover the last one used after turning it off and on again. It is only possible when you set a specific source.		
HDMI Range	Full Range	For full-range color scale signal
	Limited Range	For limited color scale signal
	Auto	Select the HDMI Range automatically.
Opening Logo	On	Opening Logo is On.
	Off	Opening Logo is Off.
LED	On	The Power Indicator is turned On.
	Off	The Power Indicator is turned Off.
<b>NOTE</b> Turn Off the Power Indicator when you are bothered by the light.		
Information	Displays information regarding the current input signal coming from the graphic card in your computer. <b>NOTE</b> See your graphic card user guide for more information about changing the resolution and refresh.	

## Direct

You can skip the Menu items and directly display an option setting screen by using the following button operations.

- Signal Select: Press the INPUT Button when the Menu is not displayed, it shows following Menu.



- Lock Mode :

### <OSD>

Hold the MENU button and turn on the monitor when the monitor is power-off, it will lock/unlock the OSD Lock function.

### <Power/OSD>

Pressing and holding the MENU button for 10 seconds when Menu is not displayed, will lock/unlock the Power/OSD Lock function.

### ■ Function Correlation Matrix

Item to be selected Item activated	Picture Adjust					Image Settings	Extra1	
	Contrast	Brightness	i-Style Color	ACR	Eco	Blue Light Reducer	MBR	FreeSync
i-Style Color	-	-	-	-	-	-	-	-
ACR	-	-	-	-	-	-	-	-
Eco	✓	-	-	-	-	-	-	✓
Blue Light Reducer	✓	✓	-	-	-	-	-	✓
MBR	✓	-	✓	-	-	-	-	-
FreeSync	✓	✓	-	-	✓	✓	-	-

✓ : Available

- : Not available

## STANDBY FEATURE

This product features the standby function. When activated, it automatically reduces unnecessary power consumption of the monitor when your computer is not in use.

There is a standby step the monitor takes as described below. The standby function, including any timer settings is configured by the operating system. Check your operating system manual for information on how this can be configured.

### ■ Standby Mode

When the video signal from the computer is off, the monitor enters into Standby Mode which reduces the power consumption to less than 0.5W\*. The screen becomes dark, and the power indicator turns to orange. From Standby Mode, the image reappears in several seconds when either the keyboard or the mouse are touched again.

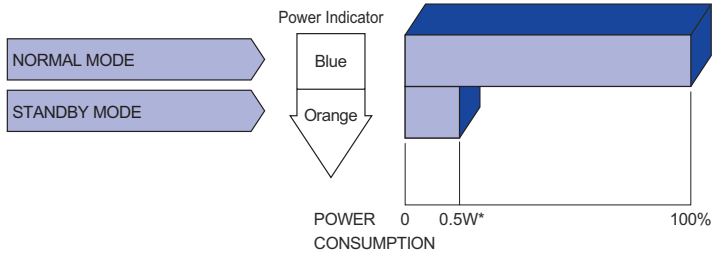

\* When the USB devices are not connected.

# TROUBLE SHOOTING

If the monitor fails to operate correctly, please follow the steps below for a possible solution.

1. Perform the adjustments described in OPERATING THE MONITOR, depending on the problem you have. If the monitor does not get a picture, skip to 2.
2. Consult the following items if you cannot find an appropriate adjustment item in OPERATING THE MONITOR or if the problem persists.
3. If you are experiencing a problem which is not described below or you cannot correct the problem, discontinue using the monitor and contact your dealer or iiyama service center for further assistance.

## Problem

## Check

- ① The picture does not appear.

(Power indicator does not light up.)

- The Power Cable is firmly seated in the socket.
- The Power Switch is turned ON.
- The AC socket is live. Please check with another piece of equipment.

(Power indicator is blue.)

- If the blank screen saver is in active mode, touch the keyboard or the mouse.
- Increase the Contrast and/or Brightness.
- The computer is ON.
- The Signal Cable is properly connected.
- The signal timing of the computer is within the specification of the monitor.

(Power indicator is orange.)

- If the monitor is in standby mode, touch the keyboard or the mouse.
- The computer is ON.
- The Signal Cable is properly connected.
- The signal timing of the computer is within the specification of the monitor.

- ② The screen is not synchronized.

- The Signal Cable is properly connected.
- The signal timing of the computer is within the specification of the monitor.

- ③ The screen position is not in the center.

- The signal timing of the computer is within the specification of the monitor.

- ④ The screen is too bright or too dark.

- The video output level of the computer is within the specification of the monitor.

- ⑤ The screen is shaking.

- The power voltage is within the specification of the monitor.
- The signal timing of the computer is within the specification of the monitor.



## Problem

## Check

- ⑥ No sound.
- The audio equipment (computer etc.) is ON.
  - The Audio Cable is properly connected.
  - The Volume is turned up.
  - The Mute is OFF.
  - The audio output level of the audio equipment is within the specification of the monitor.
- ⑦ The sound is too loud or too quiet.
- The audio output level of the audio equipment is within the specification of the monitor.
- ⑧ A strange noise is heard.
- The Audio Cable is properly connected.

## RECYCLING INFORMATION

For better environment protection please don't dispose your monitor.  
Please visit our web site: <https://iiyama.com> for monitor recycling.

# APPENDIX

Design and specifications are subject to change without prior notice.

## SPECIFICATIONS : ProLite XUB2792HSU-B6 / W6

ENGLISH

Size Category	27"	
LCD Panel	Panel technology	IPS (In-Plane-Switching)
	Size	Diagonal: 27" (68.6cm)
	Pixel pitch	0.311mm H × 0.311mm V
	Brightness	250cd/m <sup>2</sup> (Typical), 155cd/m <sup>2</sup> (Default / Energy Saving)
	Contrast ratio	1300 : 1 (Typical), Adv. Contrast Function Available
	Viewable angle	Right / Left : 89 degrees each, Up / Down : 89 degrees each (Typical)
	MPRT	0.4ms
Display Colors	Approx. 16.7M	
Sync Frequency	HDMI(FreeSync: Off): Horizontal: 30.0-115.0kHz, Vertical: 48-100Hz HDMI(FreeSync: On): Horizontal: 30.0-115.0kHz, Vertical: 48-100Hz DisplayPort(FreeSync: Off): Horizontal: 30.0-115.0kHz, Vertical: 48-100Hz DisplayPort(FreeSync: On): Horizontal: 30.0-115.0kHz, Vertical: 48-100Hz	
Native Resolution	1920 × 1080, 2.1 MegaPixels	
Support max. resolution	HDMI(FreeSync: Off): 1920 × 1080, 100Hz HDMI(FreeSync: On): 1920 × 1080, 100Hz DisplayPort(FreeSync: Off): 1920 × 1080, 100Hz DisplayPort(FreeSync: On): 1920 × 1080, 100Hz	
Input Connector	HDMI, DisplayPort	
Input Video Signal	HDMI, DisplayPort	
USB Standard	USB3.2 Gen 1 (5Gbps, DC5V, 900mA)	
Number of USB Ports	1 Upstream : Series B	
Connector shape	4 Downstream : Series A	
Headphone Connector	ø 3.5mm mini jack (Stereo)	
Speakers	2W × 2 (Stereo speakers)	
Maximum Screen Size	597.9mm W × 336.3mm H / 23.5" W × 13.2" H	
Power Source	100-240VAC, 50/60Hz, 1.5A	
Power Consumption *	18W typical, 17W (Default / Energy Saving) Standby mode: 0.5W maximum, Off mode: 0.3W maximum	
Dimensions / Net Weight	612.5 × 394.0 - 544.0 × 209.5mm / 24.1 × 15.5 - 21.4 × 8.3" (W×H×D) 5.7kg / 12.6lbs	
Height Adjustment Range	150mm	
Angle	Tilt: Upward: 22 degrees, Downward: 5 degrees Swivel: Left / Right: 45 degrees each Rotation: Clockwise / Counterclockwise: 90 degrees each	
Environmental Considerations	Operating: Temperature 5 to 35°C / 41 to 95°F Humidity 10 to 80% (No condensation) Storage: Temperature -20 to 60°C / -4 to 140°F Humidity 10 to 90% (No condensation)	
Approvals	TCO Certified, CE, UKCA, TÜV-Bauart, VCCI, PSE, EAC	

**NOTE** \* When the USB devices are not connected.

## SPECIFICATIONS : ProLite XU2792HSU-B6

Size Category	27"	
LCD Panel	Panel technology	IPS (In-Plane-Switching)
	Size	Diagonal: 27" (68.6cm)
	Pixel pitch	0.311mm H × 0.311mm V
	Brightness	250cd/m <sup>2</sup> (Typical), 155cd/m <sup>2</sup> (Default / Energy Saving)
	Contrast ratio	1300 : 1 (Typical), Adv. Contrast Function Available
	Viewable angle	Right / Left : 89 degrees each, Up / Down : 89 degrees each (Typical)
	MPRT	0.4ms
Display Colors	Approx. 16.7M	
Sync Frequency	HDMI(FreeSync: Off): Horizontal: 30.0-115.0kHz, Vertical: 48-100Hz HDMI(FreeSync: On): Horizontal: 30.0-115.0kHz, Vertical: 48-100Hz DisplayPort(FreeSync: Off): Horizontal: 30.0-115.0kHz, Vertical: 48-100Hz DisplayPort(FreeSync: On): Horizontal: 30.0-115.0kHz, Vertical: 48-100Hz	
Native Resolution	1920 × 1080, 2.1 MegaPixels	
Support max. resolution	HDMI(FreeSync: Off): 1920 × 1080, 100Hz HDMI(FreeSync: On): 1920 × 1080, 100Hz DisplayPort(FreeSync: Off): 1920 × 1080, 100Hz DisplayPort(FreeSync: On): 1920 × 1080, 100Hz	
Input Connector	HDMI, DisplayPort	
Input Video Signal	HDMI, DisplayPort	
USB Standard	USB3.2 Gen 1 (5Gbps, DC5V, 900mA)	
Number of USB Ports	1 Upstream : Series B	
Connector shape	4 Downstream : Series A	
Headphone Connector	ø 3.5mm mini jack (Stereo)	
Speakers	2W × 2 (Stereo speakers)	
Maximum Screen Size	597.9mm W × 336.3mm H / 23.5" W × 13.2" H	
Power Source	100-240VAC, 50/60Hz, 1.5A	
Power Consumption *	18W typical, 17W (Default / Energy Saving) Standby mode: 0.5W maximum, Off mode: 0.3W maximum	
Dimensions / Net Weight	612.5 × 431.5 × 199.5mm / 24.1 × 17.0 × 7.9" (W×H×D) 4.2kg / 9.3lbs	
Tilt Angle	Upward: 21.5 degrees Downward: 3.5 degrees	
Environmental Considerations	Operating: Temperature 5 to 35°C / 41 to 95°F Humidity 10 to 80% (No condensation) Storage: Temperature -20 to 60°C / -4 to 140°F Humidity 10 to 90% (No condensation)	
Approvals	TCO Certified, CE, UKCA, TÜV-Bauart, VCCI, PSE, EAC	

**NOTE** \* When the USB devices are not connected.

## SPECIFICATIONS : ProLite XUB2492HSU-B6 / W6

Size Category		24"
LCD Panel	Panel technology	IPS (In-Plane-Switching)
	Size	Diagonal: 23.8" (60.5cm)
	Pixel pitch	0.275mm H × 0.275mm V
	Brightness	250cd/m <sup>2</sup> (Typical), 155cd/m <sup>2</sup> (Default / Energy Saving)
	Contrast ratio	1300 : 1 (Typical), Adv. Contrast Function Available
	Viewable angle	Right / Left : 89 degrees each, Up / Down : 89 degrees each (Typical)
	MPRT	0.4ms
Display Colors		Approx. 16.7M
Sync Frequency		HDMI(FreeSync: Off): Horizontal: 30.0-115.0kHz, Vertical: 48-100Hz HDMI(FreeSync: On): Horizontal: 30.0-115.0kHz, Vertical: 48-100Hz DisplayPort(FreeSync: Off): Horizontal: 30.0-115.0kHz, Vertical: 48-100Hz DisplayPort(FreeSync: On): Horizontal: 30.0-115.0kHz, Vertical: 48-100Hz
Native Resolution		1920 × 1080, 2.1 MegaPixels
Support max. resolution		HDMI(FreeSync: Off): 1920 × 1080, 100Hz HDMI(FreeSync: On): 1920 × 1080, 100Hz DisplayPort(FreeSync: Off): 1920 × 1080, 100Hz DisplayPort(FreeSync: On): 1920 × 1080, 100Hz
Input Connector		HDMI, DisplayPort
Input Video Signal		HDMI, DisplayPort
USB Standard		USB3.2 Gen 1 (5Gbps, DC5V, 900mA)
Number of USB Ports		1 Upstream : Series B
Connector shape		4 Downstream : Series A
Headphone Connector		ø 3.5mm mini jack (Stereo)
Speakers		2W × 2 (Stereo speakers)
Maximum Screen Size		527.0mm W × 296.5mm H / 20.7" W × 11.7" H
Power Source		100-240VAC, 50/60Hz, 1.5A
Power Consumption *		15W typical, 13W (Default / Energy Saving) Standby mode: 0.5W maximum, Off mode: 0.3W maximum
Dimensions / Net Weight		539.5 × 343.0 - 493.0 × 209.5mm / 21.2 × 13.5 - 19.4 × 8.3" (W×H×D) 4.9kg / 10.8lbs
Height Adjustment Range		150mm
Angle		Tilt: Upward: 22 degrees, Downward: 5 degrees Swivel: Left / Right: 45 degrees each Rotation: Clockwise / Counterclockwise: 90 degrees each
Environmental Considerations		Operating: Temperature 5 to 35°C / 41 to 95°F Humidity 10 to 80% (No condensation) Storage: Temperature -20 to 60°C / -4 to 140°F Humidity 10 to 90% (No condensation)
Approvals		TCO Certified, CE, UKCA, TÜV-Bauart, VCCI, PSE, EAC

**NOTE** \* When the USB devices are not connected.

## SPECIFICATIONS : ProLite XU2492HSU-B6

Size Category	24"	
LCD Panel	Panel technology	IPS (In-Plane-Switching)
	Size	Diagonal: 23.8" (60.5cm)
	Pixel pitch	0.275mm H × 0.275mm V
	Brightness	250cd/m <sup>2</sup> (Typical), 155cd/m <sup>2</sup> (Default / Energy Saving)
	Contrast ratio	1300 : 1 (Typical), Adv. Contrast Function Available
	Viewable angle	Right / Left : 89 degrees each, Up / Down : 89 degrees each (Typical)
	MPRT	0.4ms
Display Colors	Approx. 16.7M	
Sync Frequency	HDMI(FreeSync: Off): Horizontal: 30.0-115.0kHz, Vertical: 48-100Hz HDMI(FreeSync: On): Horizontal: 30.0-115.0kHz, Vertical: 48-100Hz DisplayPort(FreeSync: Off): Horizontal: 30.0-115.0kHz, Vertical: 48-100Hz DisplayPort(FreeSync: On): Horizontal: 30.0-115.0kHz, Vertical: 48-100Hz	
Native Resolution	1920 × 1080, 2.1 MegaPixels	
Support max. resolution	HDMI(FreeSync: Off): 1920 × 1080, 100Hz HDMI(FreeSync: On): 1920 × 1080, 100Hz DisplayPort(FreeSync: Off): 1920 × 1080, 100Hz DisplayPort(FreeSync: On): 1920 × 1080, 100Hz	
Input Connector	HDMI, DisplayPort	
Input Video Signal	HDMI, DisplayPort	
USB Standard	USB3.2 Gen 1 (5Gbps, DC5V, 900mA)	
Number of USB Ports	1 Upstream : Series B	
Connector shape	4 Downstream : Series A	
Headphone Connector	ø 3.5mm mini jack (Stereo)	
Speakers	2W × 2 (Stereo speakers)	
Maximum Screen Size	527.0mm W × 296.5mm H / 20.7" W × 11.7" H	
Power Source	100-240VAC, 50/60Hz, 1.5A	
Power Consumption *	15W typical, 13W (Default / Energy Saving) Standby mode: 0.5W maximum, Off mode: 0.3W maximum	
Dimensions / Net Weight	539.5 × 415.0 × 199.5mm / 21.2 × 16.3 × 7.9" (W×H×D) 3.4kg / 7.5lbs	
Tilt Angle	Upward: 21.5 degrees Downward: 3.5 degrees	
Environmental Considerations	Operating: Temperature 5 to 35°C / 41 to 95°F Humidity 10 to 80% (No condensation) Storage: Temperature -20 to 60°C / -4 to 140°F Humidity 10 to 90% (No condensation)	
Approvals	TCO Certified, CE, UKCA, TÜV-Bauart, VCCI, PSE, EAC	

**NOTE** \* When the USB devices are not connected.

## SPECIFICATIONS : ProLite XUB2292HSU-B6 / W6

Size Category		22"
LCD Panel	Panel technology	IPS (In-Plane-Switching)
	Size	Diagonal: 21.5" (54.6cm)
	Pixel pitch	0.248mm H × 0.248mm V
	Brightness	250cd/m <sup>2</sup> (Typical), 155cd/m <sup>2</sup> (Default / Energy Saving)
	Contrast ratio	1000 : 1 (Typical), Adv. Contrast Function Available
	Viewable angle	Right / Left : 89 degrees each, Up / Down : 89 degrees each (Typical)
	MPRT	0.4ms
Display Colors		Approx. 16.7M
Sync Frequency		HDMI(FreeSync: Off): Horizontal: 30.0-115.0kHz, Vertical: 48-100Hz HDMI(FreeSync: On): Horizontal: 30.0-115.0kHz, Vertical: 48-100Hz DisplayPort(FreeSync: Off): Horizontal: 30.0-115.0kHz, Vertical: 48-100Hz DisplayPort(FreeSync: On): Horizontal: 30.0-115.0kHz, Vertical: 48-100Hz
Native Resolution		1920 × 1080, 2.1 MegaPixels
Support max. resolution		HDMI(FreeSync: Off): 1920 × 1080, 100Hz HDMI(FreeSync: On): 1920 × 1080, 100Hz DisplayPort(FreeSync: Off): 1920 × 1080, 100Hz DisplayPort(FreeSync: On): 1920 × 1080, 100Hz
Input Connector		HDMI, DisplayPort
Input Video Signal		HDMI, DisplayPort
USB Standard		USB3.2 Gen 1 (5Gbps, DC5V, 900mA)
Number of USB Ports		1 Upstream : Series B
Connector shape		4 Downstream : Series A
Headphone Connector		ø 3.5mm mini jack (Stereo)
Speakers		2W × 2 (Stereo speakers)
Maximum Screen Size		476.1mm W × 267.8mm H / 18.7" W × 10.5" H
Power Source		100-240VAC, 50/60Hz, 1.5A
Power Consumption *		16W typical, 14W (Default / Energy Saving) Standby mode: 0.5W maximum, Off mode: 0.3W maximum
Dimensions / Net Weight		489.5 × 336.5 - 486.5 × 209.5mm / 19.3 × 13.2 - 19.2 × 8.3" (W×H×D) 4.5kg / 9.9lbs
Height Adjustment Range		150mm
Angle		Tilt: Upward: 22 degrees, Downward: 5 degrees Swivel: Left / Right: 45 degrees each Rotation: Clockwise / Counterclockwise: 90 degrees each
Environmental Considerations		Operating: Temperature 5 to 35°C / 41 to 95°F Humidity 10 to 80% (No condensation) Storage: Temperature -20 to 60°C / -4 to 140°F Humidity 10 to 90% (No condensation)
Approvals		TCO Certified, CE, UKCA, TÜV-Bauart, VCCI, PSE, EAC

**NOTE** \* When the USB devices are not connected.

## SPECIFICATIONS : ProLite XU2292HSU-B6

Size Category	22"	
LCD Panel	Panel technology	IPS (In-Plane-Switching)
	Size	Diagonal: 21.5" (54.6cm)
	Pixel pitch	0.248mm H × 0.248mm V
	Brightness	250cd/m <sup>2</sup> (Typical), 155cd/m <sup>2</sup> (Default / Energy Saving)
	Contrast ratio	1000 : 1 (Typical), Adv. Contrast Function Available
	Viewable angle	Right / Left : 89 degrees each, Up / Down : 89 degrees each (Typical)
	MPRT	0.4ms
Display Colors	Approx. 16.7M	
Sync Frequency	HDMI(FreeSync: Off): Horizontal: 30.0-115.0kHz, Vertical: 48-100Hz HDMI(FreeSync: On): Horizontal: 30.0-115.0kHz, Vertical: 48-100Hz DisplayPort(FreeSync: Off): Horizontal: 30.0-115.0kHz, Vertical: 48-100Hz DisplayPort(FreeSync: On): Horizontal: 30.0-115.0kHz, Vertical: 48-100Hz	
Native Resolution	1920 × 1080, 2.1 MegaPixels	
Support max. resolution	HDMI(FreeSync: Off): 1920 × 1080, 100Hz HDMI(FreeSync: On): 1920 × 1080, 100Hz DisplayPort(FreeSync: Off): 1920 × 1080, 100Hz DisplayPort(FreeSync: On): 1920 × 1080, 100Hz	
Input Connector	HDMI, DisplayPort	
Input Video Signal	HDMI, DisplayPort	
USB Standard	USB3.2 Gen 1 (5Gbps, DC5V, 900mA)	
Number of USB Ports	1 Upstream : Series B	
Connector shape	4 Downstream : Series A	
Headphone Connector	ø 3.5mm mini jack (Stereo)	
Speakers	2W × 2 (Stereo speakers)	
Maximum Screen Size	476.1mm W × 267.8mm H / 18.7" W × 10.5" H	
Power Source	100-240VAC, 50/60Hz, 1.5A	
Power Consumption *	16W typical, 14W (Default / Energy Saving) Standby mode: 0.5W maximum, Off mode: 0.3W maximum	
Dimensions / Net Weight	489.5 × 384.0 × 199.5mm / 19.3 × 15.1 × 7.9" (W×H×D) 3.0kg / 6.6lbs	
Tilt Angle	Upward: 21.5 degrees Downward: 3.5 degrees	
Environmental Considerations	Operating: Temperature 5 to 35°C / 41 to 95°F Humidity 10 to 80% (No condensation) Storage: Temperature -20 to 60°C / -4 to 140°F Humidity 10 to 90% (No condensation)	
Approvals	TCO Certified, CE, UKCA, TÜV-Bauart, VCCI, PSE, EAC	

**NOTE** \* When the USB devices are not connected.

## DIMENSIONS : ProLite XUB2792HSU

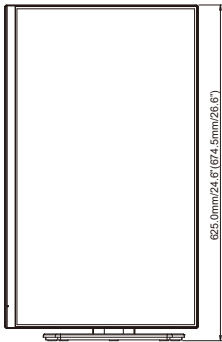
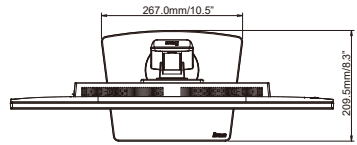
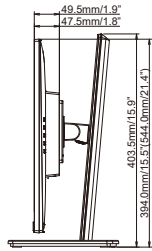
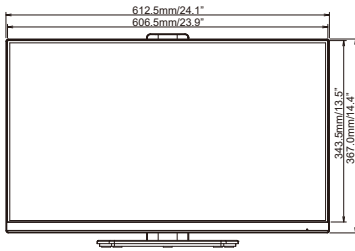

( ) : Maximum adjustment range

## DIMENSIONS : ProLite XU2792HSU

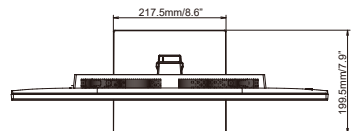
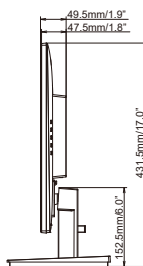
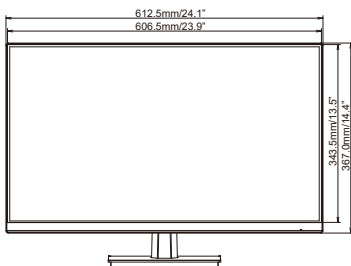



## DIMENSIONS : ProLite XUB2492HSU

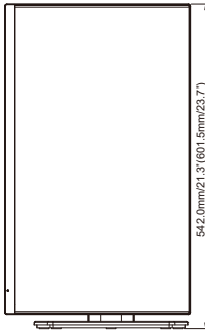
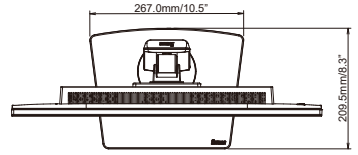
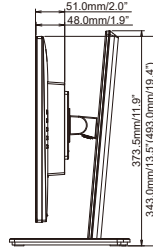
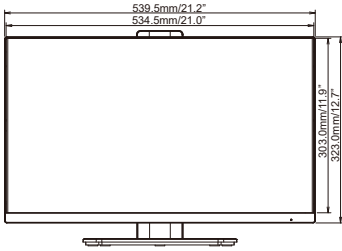

( ) : Maximum adjustment range

ENGLISH

## DIMENSIONS : ProLite XU2492HSU

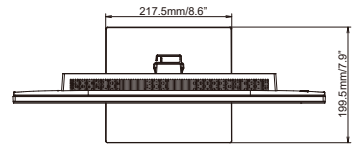
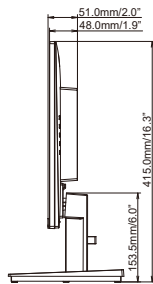
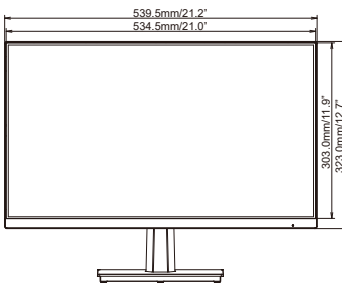

## DIMENSIONS : ProLite XUB2292HSU

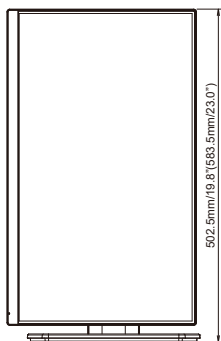
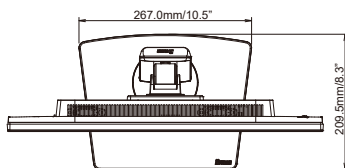
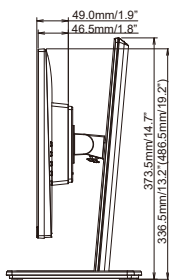
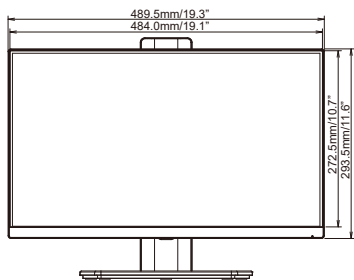

( ) : Maximum adjustment range

## DIMENSIONS : ProLite XU2292HSU

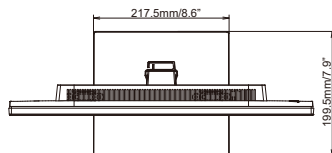
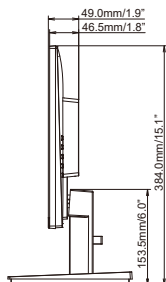
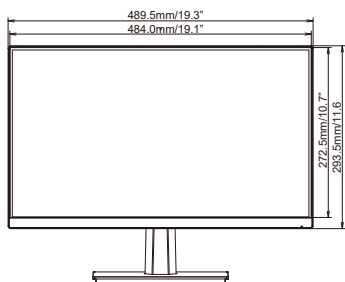

## COMPLIANT TIMING

Video Mode	Horizontal Frequency	Vertical Frequency	Dot Clock
800 × 600	37.879kHz	60.317Hz	40.000MHz
	46.875kHz	75.000Hz	49.500MHz
1024 × 768	48.363kHz	60.004Hz	65.000MHz
	60.023kHz	75.029Hz	78.750MHz
1280 × 1024	63.981kHz	60.020Hz	108.000MHz
	79.976kHz	75.025Hz	135.000MHz
1680 × 1050	65.290kHz	60.000Hz	146.250MHz
1920 × 1080	67.500kHz	60.000Hz	148.500MHz
	83.890kHz	74.970Hz	174.500MHz
	95.540kHz	85.000Hz	198.723MHz
	110.000kHz	100.000Hz	228.800MHz