

# USER MANUAL

# ***G-MASTER***

## **LCD Monitor**

ENGLISH

***G-MASTER GB2445HSU***

***G-MASTER GB2745HSU***

***G-MASTER GB2745QSU***

***G-MASTER G2445HSU***

***G-MASTER G2745HSU***

***G-MASTER G2745QSU***

***G-MASTER GB2455HSU***

***G-MASTER GB2755HSU***

***G-MASTER GB2755QSU***

***G-MASTER G2455HSU***

***G-MASTER G2755HSU***

***G-MASTER G2755QSU***

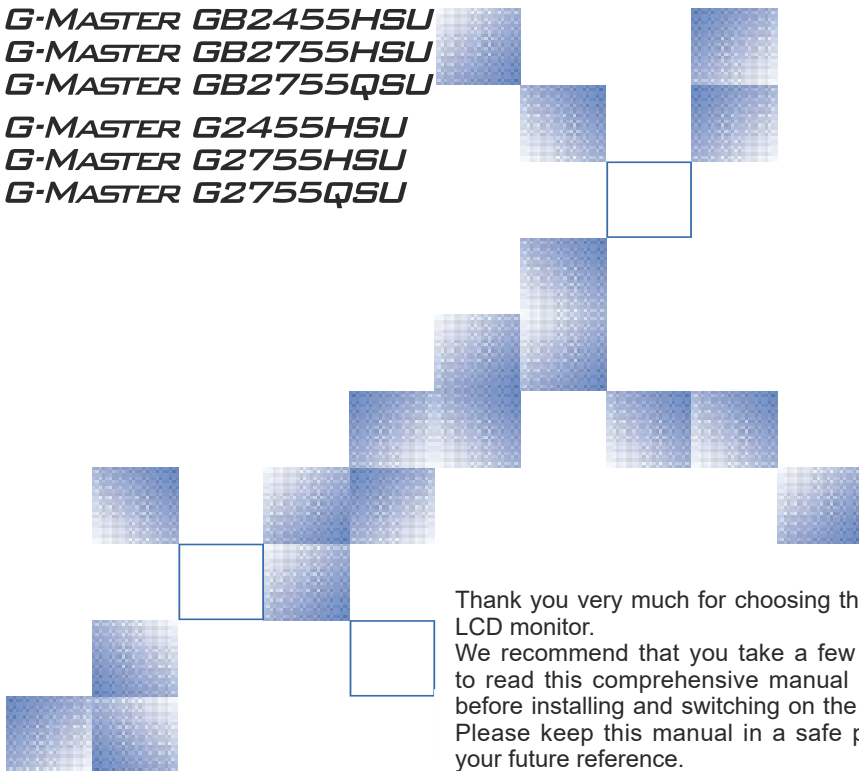

Thank you very much for choosing the iiyama LCD monitor.

We recommend that you take a few minutes to read this comprehensive manual carefully before installing and switching on the monitor. Please keep this manual in a safe place for your future reference.



## Dear user, we congratulate you on the purchase of your iiyama LCD.

For details on warranty and locally used pixel policies that apply directly after installation of your product please check the iiyama website.

### To report a fault, please contact your local support centre found at <https://iiyama.com>

#### Things to check before you call the iiyama information line

- | if the power cable is connected securely and turned on?
- | if the display has been turned on?
- | if the signal cable is connected securely and the correct input selected?
- | if the computer has been restarted with the display connected?
- | if the graphics card is correctly installed with the latest drivers possible?
- | if the correct native resolution has been selected via 'Display Properties'?
- | if the R/G/B signal configuration is correct?
- | if the displays On Screen Menu is shown?
- | if the correct brightness and contrast settings have been set?
- | if given display tolerances and compatibility have been considered?
- | if via the On Screen Menu you have performed a Factory Reset/Recall?



#### Before reporting the screen defect, please prepare the following information/evidence:

- | model number \*
- | purchase receipt and serial number \*
- | name and address for collection
- | telephone/fax number, for availability during the day
- | convenient collection date (date, time)
- | short description of the defect

#### Important Note:

If there is no fault found in the collected equipment after inspection, the transferring party shall incur charges for transport and administration.

If you have checked all of the above and there is still no picture, call our information line for assistance in your country.

\* see the identification plate on the back of the case.

## CE MARKING DECLARATION OF CONFORMITY

This LCD monitor complies with the requirements of the EC/EU Directive 2014/30/EU "EMC Directive", 2014/35/EU "Low Voltage Directive", 2009/125/EC "ErP Directive" and 2011/65/EU "RoHS Directive".

The electro-magnetic susceptibility has been chosen at a level that gives correct operation in residential areas, business and light industrial premises and small-scale enterprises, inside as well as outside of the buildings. All places of operation are characterised by their connection to the public low voltage power supply system.

IYAMA CORPORATION: Wijkmeerstraat 8, 2131 HA Hoofddorp, The Netherlands

Model No. : PL2445HS, PL2745HS, PL2745QS  
PL2455HS, PL2755HS, PL2755QS



We recommend recycling of used product. Please contact your dealer or iiyama service center. Recycle information is obtained via the Internet, using the address: <https://iiyama.com>  
You can access the Web page of different countries from there.

- We reserve the right to change specifications without notice.
- All trademarks used in this user manual are the property of their respective owners.
- The terms HDMI and HDMI High-Definition Multimedia Interface, and the HDMI Logo are trademarks or registered trademarks of HDMI Licensing Administrator, Inc. in the United States and other countries.
- The font used in the OSD menu is licensed under the Apache License, Version 2.0. You may obtain a copy of the License at <http://www.apache.org/licenses/LICENSE-2.0>
- Eprel registration number
  - GB2445HSU-B1 : 1660657
  - GB2745HSU-B1 : 1703803
  - GB2745QSU-B1 : 1692557
  - G2445HSU-B1 : 1660690
  - G2745HSU-B1 : 1704132
  - G2745QSU-B1 : 1692561
  - GB2455HSU-B1 : 1589946
  - GB2755HSU-B1 : 1593353
  - GB2755QSU-B1 : 1607352
  - G2455HSU-B1 : 1590832
  - G2755HSU-B1 : 1593439
  - G2755QSU-B1 : 1607379

# TABLE OF CONTENTS

FOR YOUR SAFETY.....	1
SAFETY PRECAUTIONS.....	1
SPECIAL NOTES ON LCD MONITORS.....	3
CUSTOMER SERVICE.....	3
CLEANING.....	3
BEFORE YOU OPERATE THE MONITOR.....	4
FEATURES.....	4
CHECKING THE CONTENTS OF THE PACKAGE.....	5
USING ARM OR STAND.....	5
FITTING AND REMOVAL OF STAND : G-MASTER GB2445HSU, GB2745HSU, GB2745QSU, GB2455HSU, GB2755HSU, GB2755QSU.....	7
FITTING AND REMOVAL OF STAND : G-MASTER G2445HSU, G2745HSU, G2745QSU, G2455HSU, G2755HSU, G2755QSU....	9
CONTROLS AND CONNECTORS : G-MASTER GB2445HSU, GB2745HSU, GB2745QSU, GB2455HSU, GB2755HSU, GB2755QSU.....	11
CONTROLS AND CONNECTORS : G-MASTER G2445HSU, G2745HSU, G2745QSU, G2455HSU, G2755HSU, G2755QSU ...	12
CONNECTING YOUR MONITOR : G-MASTER GB2445HSU, GB2745HSU, GB2745QSU, GB2455HSU, GB2755HSU, GB2755QSU.....	13
CONNECTING YOUR MONITOR : G-MASTER G2445HSU, G2745HSU, G2745QSU, G2455HSU, G2755HSU, G2755QSU ..	14
COMPUTER SETTING.....	15
ADJUSTING THE HEIGHT AND THE VIEWING ANGLE : G-MASTER GB2445HSU, GB2745HSU, GB2745QSU, GB2455HSU, GB2755HSU, GB2755QSU.....	15
ADJUSTING THE VIEWING ANGLE : G-MASTER G2445HSU, G2745HSU, G2745QSU, G2455HSU, G2755HSU, G2755QSU ..	16
OPERATING THE MONITOR.....	17
ADJUSTMENT MENU CONTENTS.....	18
STANDBY FEATURE.....	29
TROUBLE SHOOTING.....	30
RECYCLING INFORMATION.....	31

APPENDIX .....	32
SPECIFICATIONS :	
G-MASTER GB2445HSU-B1, G-MASTER GB2455HSU-B1 .....	32
SPECIFICATIONS :	
G-MASTER GB2745HSU-B1, G-MASTER GB2755HSU-B1 .....	33
SPECIFICATIONS :	
G-MASTER GB2745QSU-B1, G-MASTER GB2755QSU-B1 .....	34
SPECIFICATIONS :	
G-MASTER G2445HSU-B1, G-MASTER G2455HSU-B1 .....	35
SPECIFICATIONS :	
G-MASTER G2745HSU-B1, G-MASTER G2755HSU-B1 .....	36
SPECIFICATIONS :	
G-MASTER G2745QSU-B1, G-MASTER G2755QSU-B1 .....	37
DIMENSIONS :	
G-MASTER GB2445HSU, G-MASTER GB2455HSU .....	38
DIMENSIONS :	
G-MASTER GB2745HSU, G-MASTER GB2745QSU .....	39
DIMENSIONS :	
G-MASTER GB2755HSU, G-MASTER GB2755QSU .....	39
DIMENSIONS :	
G-MASTER G2445HSU, G-MASTER G2455HSU .....	40
DIMENSIONS :	
G-MASTER G2745HSU, G-MASTER G2745QSU .....	40
DIMENSIONS :	
G-MASTER G2755HSU, G-MASTER G2755QSU .....	40
COMPLIANT TIMING .....	41

# FOR YOUR SAFETY

## SAFETY PRECAUTIONS

### WARNING

#### **STOP OPERATING THE MONITOR WHEN YOU SENSE TROUBLE**

If you notice any abnormal phenomena such as smoke, strange sounds or fumes, unplug the monitor and contact your dealer or iiyama service center immediately. Further use may be dangerous and can cause fire or electric shock.

#### **NEVER REMOVE THE CABINET**

High voltage circuits are inside the monitor. Removing the cabinet may expose you to the danger of fire or electric shock.

#### **DO NOT PUT ANY OBJECT INTO THE MONITOR**

Do not put any solid objects or liquids such as water into the monitor. In case of an accident, unplug your monitor immediately and contact your dealer or iiyama service center. Using the monitor with any object inside may cause fire, electric shock or damage.

#### **INSTALL THE MONITOR ON A FLAT, STABLE SURFACE**

The monitor may cause an injury if it falls or is dropped.

#### **DO NOT USE THE MONITOR NEAR WATER**

Do not use where water may be splashed or spilt onto the monitor as it may cause fire or electric shock.

#### **OPERATE UNDER THE SPECIFIED POWER SUPPLY**

Be sure to operate the monitor only with the specified power supply. Use of an incorrect voltage will cause malfunction and may cause fire or electric shock.

#### **PROTECT THE CABLES**

Do not pull or bend the power cable and signal cable. Do not place the monitor or any other heavy objects on the cables. If damaged, the cables may cause fire or electric shock.

#### **ADVERSE WEATHER CONDITIONS**

It is advisable not to operate the monitor during a heavy thunder storm as the continual breaks in power may cause malfunction. It is also advised not to touch the plug in these circumstances as it may cause electric shock.

## CAUTION

### INSTALLATION LOCATION

Do not install the monitor where sudden temperature changes may occur, or in humid, dusty or smoky areas as it may cause fire, electric shock or damage. You should also avoid areas where the sun shines directly on the monitor.

### DO NOT PLACE THE MONITOR IN A HAZARDOUS POSITION

The monitor may topple and cause injury if not suitably located. Please also ensure that you do not place any heavy objects on the monitor, and that all cables are routed such that children may not pull the cables and possibly cause injury.

### MAINTAIN GOOD VENTILATION

Ventilation slots are provided to keep the monitor from overheating. Covering the slots may cause fire. To allow adequate air circulation, place the monitor at least 10cm (or 4 inches) from any walls.

When removing the tilt stand, the ventilation slots on the back side of the monitor can be blocked. This may overheat the monitor and may cause fire or damage. Make sure to allow enough ventilation when removing the tilt stand. Operating the monitor on its back, side, upside down or on a carpet or any other soft material may also cause damage.

### DISCONNECT THE CABLES WHEN YOU MOVE THE MONITOR

When you move the monitor, turn off the Power Button, unplug the monitor and be sure the signal cable is disconnected. If you do not disconnect them, it may cause fire or electric shock.

### UNPLUG THE MONITOR

If the monitor is not in use for a long period of time it is recommended that it is left unplugged to avoid accidents.

### HOLD THE PLUG WHEN DISCONNECTING

To disconnect the power cable or signal cable, always pull it by the plug. Never pull on the cable itself as this may cause fire or electric shock.

### DO NOT TOUCH THE PLUG WITH WET HANDS

Pulling or inserting the plug with wet hands may cause electric shock.

### WHEN YOU INSTALL THE MONITOR ON YOUR COMPUTER

Be sure the computer is strong enough to hold the weight of the monitor, otherwise, you may damage your computer.

### CAREFUL! PROTECT YOUR HANDS AND FINGERS

- Be careful not to hurt your fingers or hands when you change the height or the angle.
- Injury can occur if care is not taken to avoid finger contact with the displays base when adjusting the height. (Just for height adjustable model.)

### REMARK FOR 24/7 USAGE

This product is not specifically designed for 24/7 usage in all environments.

### REMARK FOR WALL MOUNTING

This product is not designed for digital signage (electronic signboard) applications such as wall mounting.

## OTHERS

### ERGONOMIC RECOMMENDATIONS

To eliminate eye fatigue, do not operate the monitor against a bright background or in a dark room. For optimal viewing comfort, the monitor should be just below eye level and 40-60cm (16-24 inches) away from your eyes. When using the monitor over a prolonged time, a ten minute break every hour is recommended as looking at the screen continuously can cause eye strain.

## SPECIAL NOTES ON LCD MONITORS

The following symptoms are normal with LCD monitors and do not indicate a problem.

### NOTE

- When you first turn on the LCD monitor, the picture may not fit in the display area because of the type of computer that is used. In this case, adjust the picture position to the correct position.
- You may find slightly uneven brightness on the screen depending on the desktop pattern you use.
- Due to the nature of the LCD screen, an afterimage of the previous screen may remain after switching the image, when the same image is displayed for hours. In this case, the screen can be recovered slowly by changing the image or turning off the Power Button for some hours.

## CUSTOMER SERVICE

### NOTE

- If you have to return your unit for service and the original packaging has been discarded, please contact your dealer or iiyama service center for advice or replacement packaging.

## CLEANING

### WARNING

- If you drop any materials or liquids such as water into the monitor when cleaning, unplug the power cable immediately and contact your dealer or iiyama service center.

### CAUTION

- For safety reasons, turn off the Power Button and unplug the monitor before you clean it.

### NOTE

- To protect the LCD panel, do not scratch or rub the screen with a hard object.
- Never use any of the following strong solvents. These will damage the cabinet and the LCD screen.

Thinner	Spray-type cleaner
Benzine	Wax
Abrasive cleaner	Acid or Alkaline solvent

- Touching the cabinet with any product made from rubber or plastic for a long time may cause degeneration or loss of paint on the cabinet.

### CABINET

Stains can be removed with a cloth lightly moistened with a mild detergent solvent. Then wipe the cabinet with a soft dry cloth.

### LCD SCREEN

Periodic cleaning with a soft dry cloth is recommended.

Don't use tissue paper etc. because these will damage the LCD screen.



# BEFORE YOU OPERATE THE MONITOR

## FEATURES

- ◆ **Supports Resolutions up to 1920 × 1080**  
*G-MASTER G(B)2445HSU, G(B)2745HSU, G(B)2455HSU, G(B)2755HSU*  
**2560 × 1440**  
*G-MASTER G(B)2745QSU, G(B)2755QSU*
- ◆ **High Contrast 1000:1 (Typical)**  
*G-MASTER G(B)2745HSU*  
**1300:1 (Typical)**  
*G-MASTER G(B)2445HSU, G(B)2745QSU*  
**4000:1 (Typical)**  
*G-MASTER G(B)2455HSU, G(B)2755HSU, G(B)2755QSU*
- ◆ **Adv. Contrast Function Available**
- ◆ **Brightness 250cd/m<sup>2</sup> (Typical)**
- ◆ **Supports AMD FreeSync™ Technology**
- ◆ **Moving Picture Response Time 1ms**
- ◆ **Flicker - Free**
- ◆ **Blue Light Reducer**
- ◆ **Digital Character Smoothing**
- ◆ **2 × 2W Stereo Speakers**
- ◆ **Standby Feature**
- ◆ **VESA Mounting Standard (100mm×100mm) Compliant**
- ◆ **Keyhole for Security Lock**

## CHECKING THE CONTENTS OF THE PACKAGE

The following accessories are included in your package. Check to see if they are enclosed with the monitor. If anything is missing or damaged, please contact your local iiyama dealer or regional iiyama office.

- Power Cable \*1
- USB Cable
- Stand-Neck
- Cable Holder \*4
- HDMI Cable
- VESA Plate \*3
- Stand-Base with a screw \*3
- Safety Guide
- DisplayPort Cable \*2
- Screwdriver \*3
- Stand-Base \*4
- Quick Start Guide

### CAUTION

\*1 The rating of the Power Cable enclosed in 120V area is 10A/125V. If you are using a power supply higher than this rating, then a power cable with a rating of 10A/250V must be used. However, all guarantees and warranties are void for any problems or damage caused by a power cable not supplied by iiyama.

An approved power cable greater or equal to H05VVF, 3G, 0.75mm<sup>2</sup> must be used.

\*2 Accessory for G-MASTER G(B)2745QSU, G(B)2755QSU

\*3 Accessory for G-MASTER GB2445HSU, GB2745HSU, GB2745QSU, GB2455HSU, GB2755HSU, GB2755QSU

\*4 Accessory for G-MASTER G2445HSU, G2745HSU, G2745QSU, G2455HSU, G2755HSU, G2755QSU

## USING ARM OR STAND

### CAUTION

- Before installation, make sure the display arm or desk arm stand is strong enough to hold the necessary weight of the monitor and the mount.
- Panel angle adjustment range : 23° upward and 5° downward

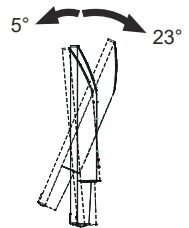

### < DISPLAY ARM OR DESK ARM STAND >

### WARNING

- When you use with the display arm or desk arm stand, in consideration of thickness of the mounting stage, tighten the M4 Screws (4pcs) which "L" length is 7mm to fasten the monitor. Using the screw longer than this may cause electric shock or damage because it may contact with the electrical parts inside the monitor.

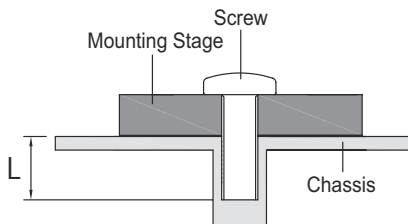

## < ROTATING THE MONITOR >

- G-MASTER GB2445HSU, GB2745HSU, GB2745QSU, GB2455HSU, GB2755HSU, GB2755QSU

The monitor is designed to be compatible with both landscape and portrait modes.  
Video card for portrait display will be required for rotating the image on the screen.

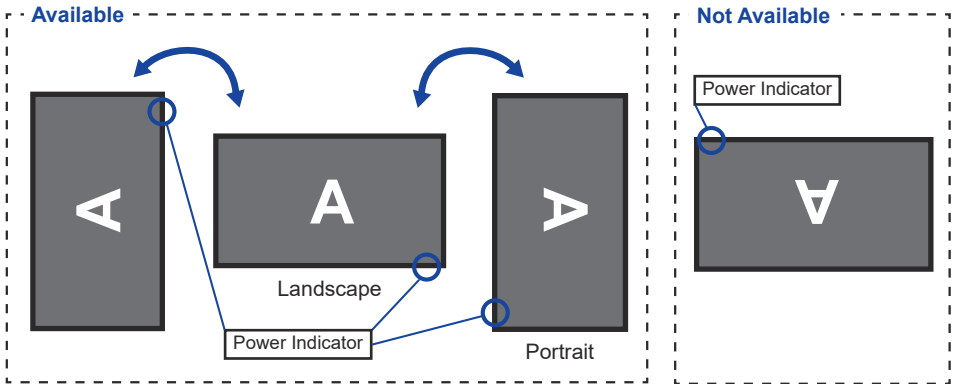

### With Stand:

#### NOTE

- Adjust the monitor's height before panel rotation.
- Attempting to rotate the panel forcibly without adjusting the stand height may cause damage to the panel or the stand.

- G-MASTER G2445HSU, G2745HSU, G2745QSU, G2455HSU, G2755HSU, G2755QSU

This monitor can only be used in landscape.

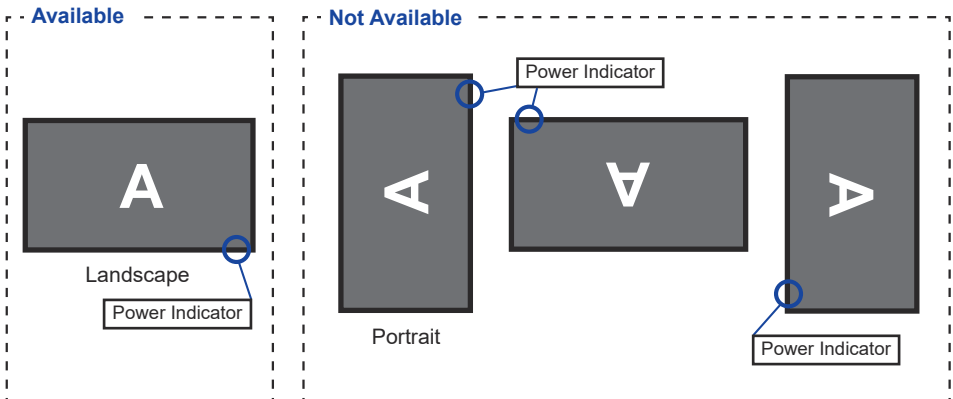

# FITTING AND REMOVAL OF STAND :

G-MASTER GB2445HSU, GB2745HSU, GB2745QSU, GB2455HSU, GB2755HSU, GB2755QSU

**CAUTION**

- Put the monitor on a stable surface. The monitor may cause injury or damage if it falls or is dropped.
- Do not give a strong impact to the monitor. It may cause damage.
- Unplug the monitor before removal or installation to avoid an electric shock or a damage.

**<Installation>**

- ① Attach the Stand-Neck to the VESA Plate and then tighten the 'thumb screw' with the provided screwdriver to secure them.

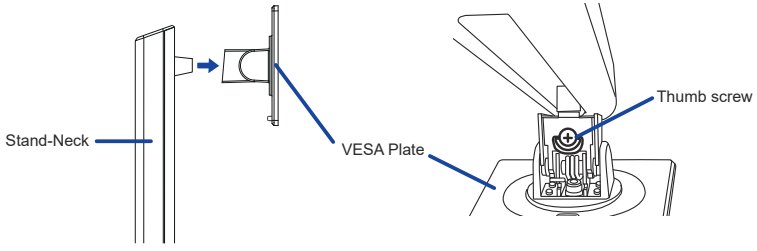

- ② Install the Stand-Base to the Stand-Neck and then tighten the 'thumb screw' with the provided screwdriver to secure them.

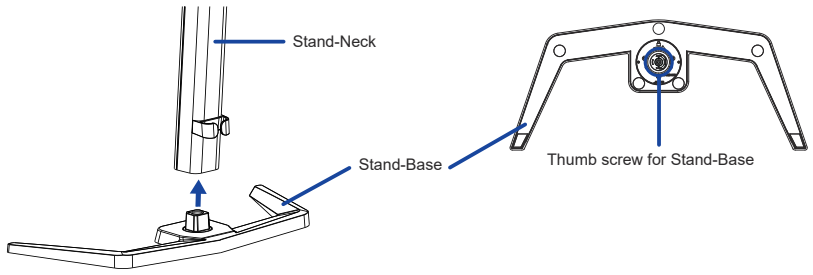

- ③ Put a piece of soft cloth on the table beforehand to prevent the monitor from being scratched. Lay the monitor flat on a table with front face down.
- ④ Hold the monitor and install the assembled stand to the monitor until it clicks to secure.

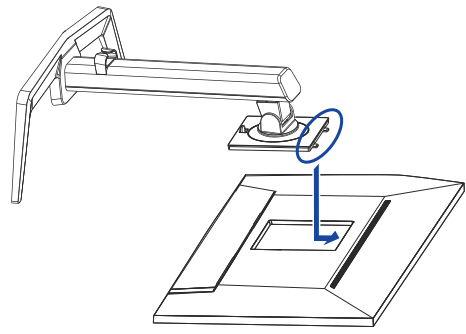

**<Removal>**

- ① Put a piece of soft cloth on the table beforehand to prevent the monitor from being scratched. Lay the monitor flat on a table with front face down.
- ② Press the release button to remove the stand.

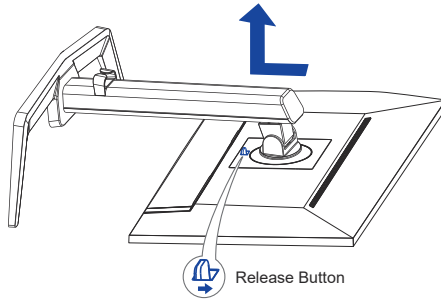

- ③ Loosen the 'thumb screw' with the provided screwdriver to remove the Stand-Neck from the VESA Plate.
- ④ Loosen the 'thumb screw' with the provided screwdriver to remove the Stand-Base from the Stand-Neck.

## FITTING AND REMOVAL OF STAND :

### G-MASTER G2445HSU, G2745HSU, G2745QSU, G2455HSU, G2755HSU, G2755QSU

#### CAUTION

- Put the monitor on a stable surface. The monitor may cause injury or damage if it falls or is dropped.
- Do not give a strong impact to the monitor. It may cause damage.
- Unplug the monitor before removal or installation to avoid an electric shock or a damage.

#### <Installation>

- ① Combine the Stand-Neck and the Stand-Base.
- ② Place the Cable Holder.

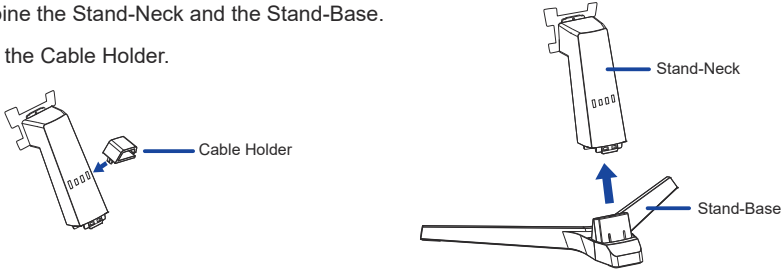

- ③ Put a piece of soft cloth on the table beforehand to prevent the monitor from being scratched. Lay the monitor flat on a table with front face down.
- ④ Hold the monitor and install the assembled stand to the monitor until it clicks to secure.

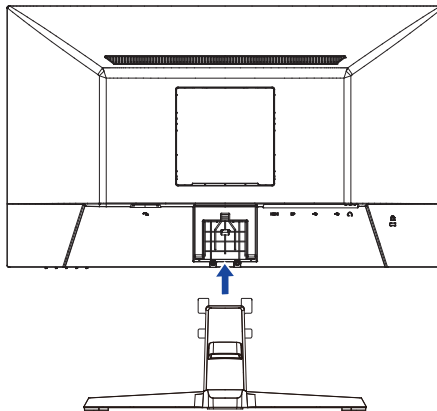

<Removal>

- ① Put a piece of soft cloth on the table beforehand to prevent the monitor from being scratched.  
Lay the monitor flat on a table with front face down.
- ② Keep pressing the Hooks inward to pull out the Stand-Base.
- ③ Press the release button and remove the Stand-Neck from the monitor.
- ④ Remove the Cable Holder.

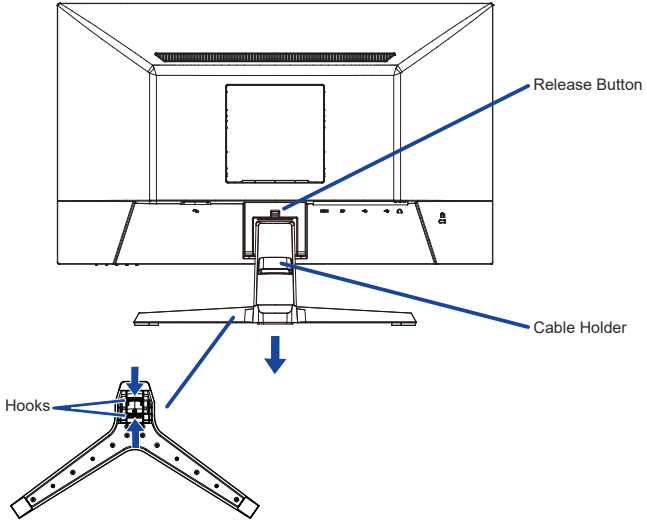

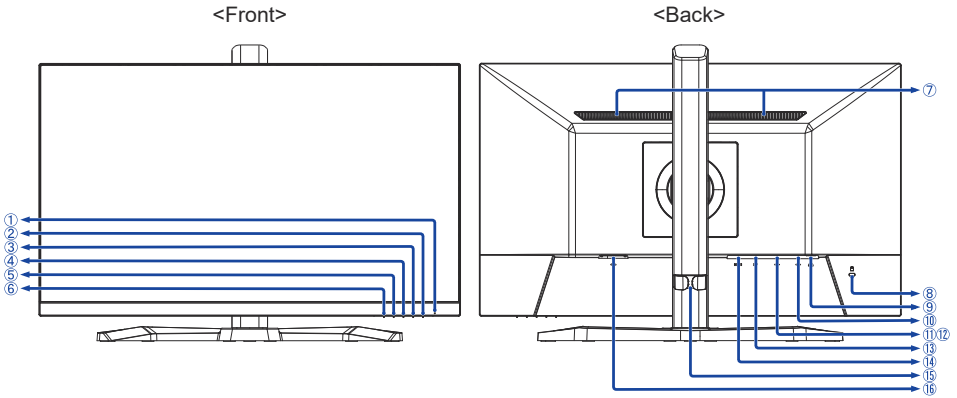

# CONTROLS AND CONNECTORS :

## G-MASTER GB2445HSU, GB2745HSU, GB2745QSU, GB2455HSU, GB2755HSU, GB2755QSU







- ① Power Indicator

**NOTE** Blue: Normal operation  
Orange: Standby Mode

- ② Power Button (  )
- ③ Menu Button (MENU)
- ④ Up / Right / Volume Button (  )
- ⑤ Down / Left / Black Tuner / MBR / AMD FreeSync / Night Mode Button (  /  )
- ⑥ Input Select / Exit Button (INPUT / EXIT)
- ⑦ Speakers
- ⑧ Keyhole for Security Lock

**NOTE** You can fasten a security lock and cable to prevent the monitor from being removed without your permission.

- ⑨ Headphone Connector (  )
- ⑩ USB Upstream Connector (  )
- ⑪ USB Downstream Connector (  USB2.0: 5V, 500mA<sup>\*1</sup> / USB3.2 Gen 1: 5Gbps, 5V, 900mA<sup>\*2</sup> )
- ⑫ USB Downstream Connector (  USB2.0: 5V, 500mA<sup>\*1</sup> / USB3.2 Gen 1: 5Gbps, 5V, 900mA<sup>\*2</sup> )
- ⑬ DisplayPort Connector (DP)
- ⑭ HDMI Connector (HDMI)
- ⑮ Cable Holder
- ⑯ AC Connector ( ~: Alternating current )

\*1 For G-MASTER GB2445HSU, GB2745HSU, GB2455HSU, GB2755HSU

\*2 For G-MASTER GB2745QSU, GB2755QSU





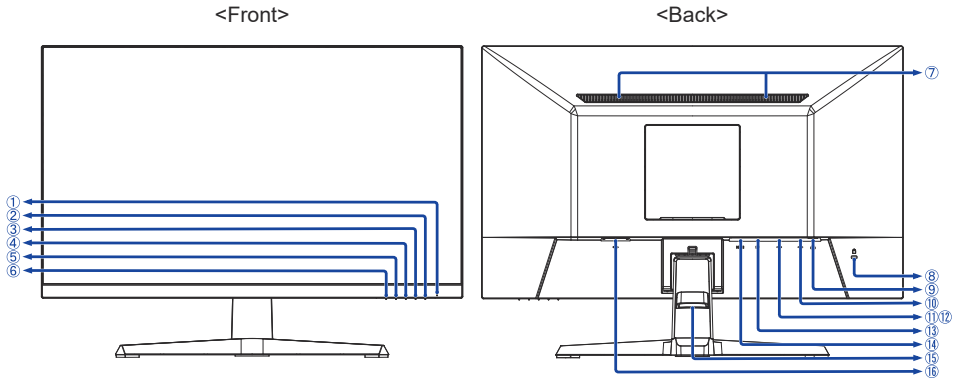

# CONTROLS AND CONNECTORS :

## G-MASTER G2445HSU, G2745HSU, G2745QSU, G2455HSU, G2755HSU, G2755QSU







- ① Power Indicator

**NOTE** Blue: Normal operation  
Orange: Standby Mode

- ② Power Button (  )
- ③ Menu Button (MENU)
- ④ Up / Right / Volume Button (  /  )
- ⑤ Down / Left / Black Tuner / MBR / AMD FreeSync / Night Mode Button (  /  )
- ⑥ Input Select / Exit Button (INPUT / EXIT)
- ⑦ Speakers
- ⑧ Keyhole for Security Lock

**NOTE** You can fasten a security lock and cable to prevent the monitor from being removed without your permission.

- ⑨ Headphone Connector (  )
- ⑩ USB Upstream Connector (  )
- ⑪ USB Downstream Connector (  USB2.0: 5V, 500mA\*<sup>1</sup> / USB3.2 Gen 1: 5Gbps, 5V, 900mA\*<sup>2</sup> )
- ⑫ USB Downstream Connector (  USB2.0: 5V, 500mA\*<sup>1</sup> / USB3.2 Gen 1: 5Gbps, 5V, 900mA\*<sup>2</sup> )
- ⑬ DisplayPort Connector (DP)
- ⑭ HDMI Connector (HDMI)
- ⑮ Cable Holder
- ⑯ AC Connector ( ~: Alternating current )

\*<sup>1</sup> For G-MASTER G2445HSU, G2745HSU, G2455HSU, G2755HSU

\*<sup>2</sup> For G-MASTER G2745QSU, G2755QSU

## CONNECTING YOUR MONITOR : G-MASTER GB2445HSU, GB2745HSU, GB2745QSU, GB2455HSU, GB2755HSU, GB2755QSU

- ① Ensure that both the computer and the monitor are switched off.
- ② Connect the computer to the monitor with the signal cable.
- ③ Connect the computer to the monitor with the USB cable.
- ④ Connect the Power Cable to the monitor first and then to the power source.
- ⑤ Turn on your monitor and computer.

### NOTE

- Make sure that the building installation has a circuit breaker of 120/240V, 20A (maximum).
- The signal cables used for connecting the computer and monitor may vary with the type of computer used. An incorrect connection may cause serious damage to both the monitor and the computer. The cable supplied with the monitor is for a standard connector. If a special cable is required please contact your local iiyama dealer or regional iiyama office.
- The Class I pluggable equipment Type A must be connected to protective earth.
- The socket-outlet shall be installed near the equipment and shall be easily accessible.
- Excessive sound pressure from ear-/headphones can cause hearing damage/hearing loss.

[Example of Connection]

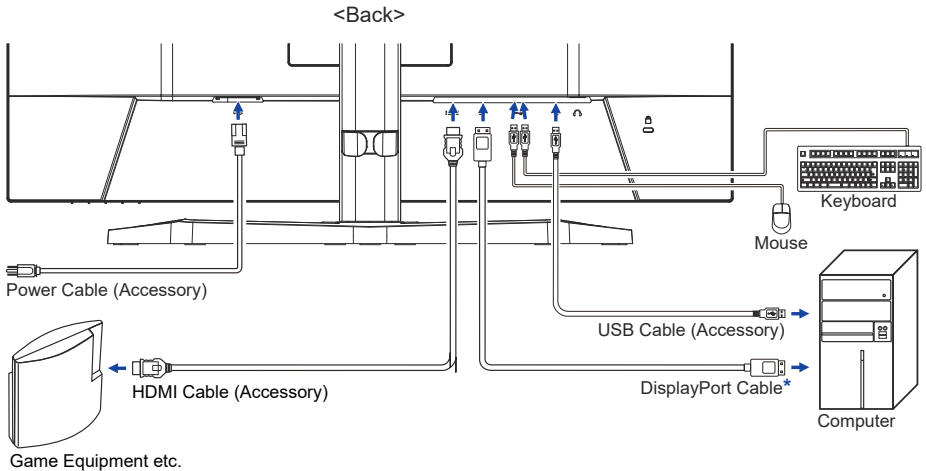

\* Accessory for G-MASTER GB2745QSU and GB2755QSU only

### [ Collect Cables ]

Put the cables through the cable holder to bundle them.

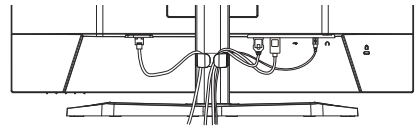

**CONNECTING YOUR MONITOR :****G-MASTER G2445HSU, G2745HSU, G2745QSU, G2455HSU, G2755HSU, G2755QSU**

- ① Ensure that both the computer and the monitor are switched off.
- ② Connect the computer to the monitor with the signal cable.
- ③ Connect the computer to the monitor with the USB cable.
- ④ Connect the Power Cable to the monitor first and then to the power source.
- ⑤ Turn on your monitor and computer.

**NOTE**

- Make sure that the building installation has a circuit breaker of 120/240V, 20A (maximum).
- The signal cables used for connecting the computer and monitor may vary with the type of computer used. An incorrect connection may cause serious damage to both the monitor and the computer. The cable supplied with the monitor is for a standard connector. If a special cable is required please contact your local iiyama dealer or regional iiyama office.
- The Class I pluggable equipment Type A must be connected to protective earth.
- The socket-outlet shall be installed near the equipment and shall be easily accessible.
- Excessive sound pressure from ear-/headphones can cause hearing damage/hearing loss.

[Example of Connection]

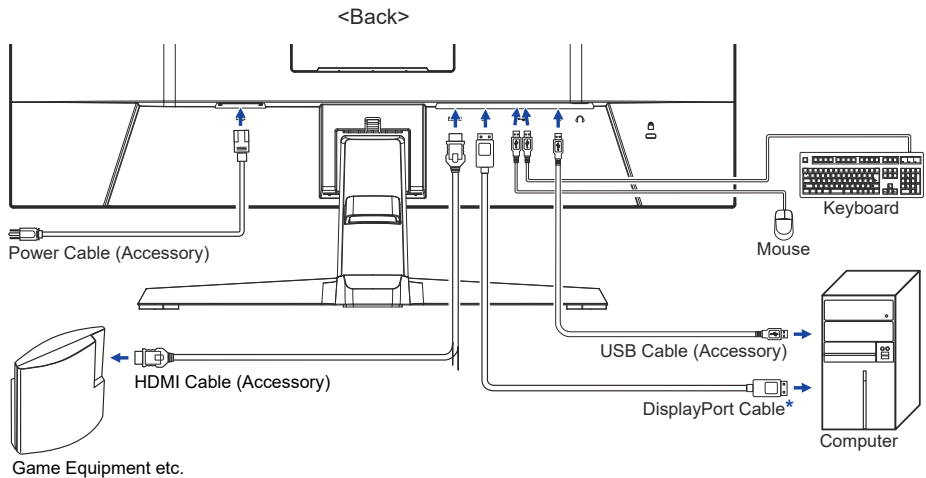
**[ Collect Cables ]**

Put the cables through the cable holder to bundle them.

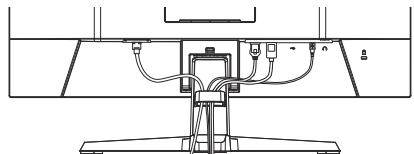

## COMPUTER SETTING

### ■ Signal Timing

Change to the desired signal timing listed on page 41: COMPLIANT TIMING.

## ADJUSTING THE HEIGHT AND THE VIEWING ANGLE : G-MASTER GB2445HSU, GB2745HSU, GB2745QSU, GB2455HSU, GB2755HSU, GB2755QSU

- For optimal viewing it is recommended to position yourself directly opposite to the full face of the monitor, then adjust the monitor's height and angle to your own preference.
- Hold the panel so that the monitor does not topple when you change the monitor's height or angle.
- You are able to adjust the monitor's height up to 150mm, angle up to 45° right and left, 23° upward and 5° downward.

### NOTE

- Do not touch the LCD screen when you change the height or the angle. It may cause damage or break the LCD screen.
- Careful attention is required not to pinch your fingers or hands into the moving part of the stand when you change the height or the angle.
- Injury can occur if care is not taken to avoid finger contact with the displays base when adjusting the height.

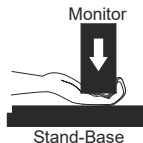
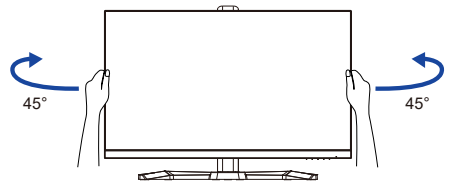
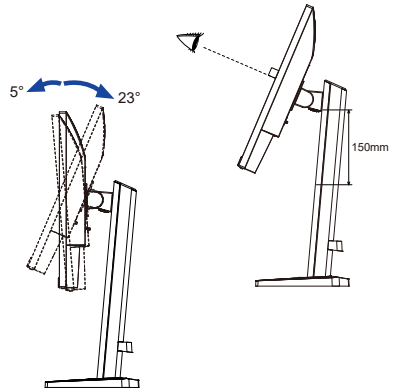

**ADJUSTING THE VIEWING ANGLE :****G-MASTER G2445HSU, G2745HSU, G2745QSU, G2455HSU, G2755HSU, G2755QSU**

- For optimal viewing it is recommended to look at the full face of the monitor.
- Hold the stand so that the monitor does not topple when you change the monitor's angle.
- You are able to adjust the monitor's angle up to 22° upward, 4° downward.
- In order to ensure a healthy and relaxed body position when using the monitor at visual display workstations, it is recommended that the adjusted tilt angle should not exceed 10°. Adjust the monitor's angle to your own preference.

**NOTE**

- Do not touch the LCD screen when you change the angle. It may cause damage or break the LCD screen.
- Careful attention is required not to pinch your fingers or hands into the moving part of the stand when you change the angle.

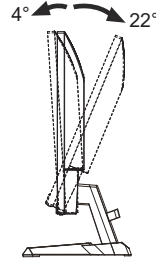
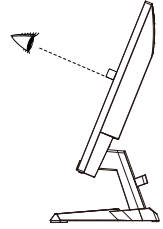

# OPERATING THE MONITOR

To create the best picture, your iiyama LCD monitor has been preset at the factory with the COMPLIANT TIMING shown on page 41. You are also able to adjust the picture by following the button operation shown below.

- 1 Press the **MENU** Button to start the On Screen Display (OSD) feature. There are additional Menu items which can be switched by using the ◀ / ▶ Buttons.



- 2 Select the Menu item which contains the adjustment icon relating to the adjustment you want to make. Press the **MENU** Button. Then, use the ◀ / ▶ Buttons to highlight the desired adjustment icon.
- 3 Press the **MENU** Button again. Use the ◀ / ▶ Buttons to make the appropriate adjustment or setting.
- 4 Press the **EXIT** Button to leave the menu, and the settings you just made would be automatically saved.

For example, to correct for OSD vertical position, select Menu item of “Setup Menu” and press the **MENU** Button. Then, select “OSD Vertical Position” by using the ◀ / ▶ Buttons and press the **MENU** Button. Use the ◀ / ▶ Buttons to change the OSD vertical position settings. The OSD vertical position should be changing accordingly while you are doing this.

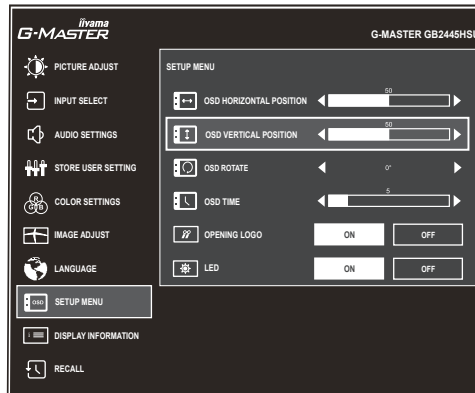

When you press the **EXIT** Button to end the adjustment, all changes are saved in the memory.

## NOTE

- When button operations are aborted during adjustment, On Screen Display disappears when the time set for the “OSD Time” has passed. Also, the **EXIT** Button can be used to return previous menu and turn off the On Screen Display.
- Any changes are automatically saved in the memory when the On Screen Display disappears. Turning off the power should be avoided while using the Menu.

# ADJUSTMENT MENU CONTENTS

## Picture Adjust \*1

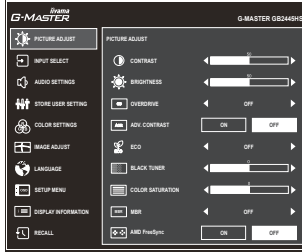

Adjustment Item	Problem / Option	Button to Press
Contrast	Too dull	
	Too intense	
Brightness *2	Too dark	
	Too bright	
Overdrive	Off / 1 / 2 / 3 / 4 / 5 Improves the gray level response time of the LCD panel. A higher level results in a faster response time.	 
Adv. Contrast	On	Increased Contrast Ratio
	Off	Typical Contrast Ratio
Eco <span style="float: right;"><b>Direct</b></span>	Off	Normal
	Mode 1	Brightness of back-light is reduced.
	Mode 2	Brightness of back-light is reduced more than Mode 1.
	Mode 3	Brightness of back-light is reduced more than Mode 2.
Black Tuner <span style="float: right;"><b>Direct</b></span>	From -5 to +5 You can adjust Dark shades.	 
Color Saturation	Too weak	
	Too strong	
MBR *3 <span style="float: right;"><b>Direct</b></span>	Off / 1 / 2 / 3 / 4 / 5 / 6 / 7 Reduces motion blur on the LCD panel.	 
AMD FreeSync <span style="float: right;"><b>Direct</b></span>	On	Activates the FreeSync function.
	Off	The FreeSync function is turned off.

\*1 Adjustments and settings may not be possible due to other items that are enabled. See the "Function Correlation Matrix" on the next page for more details.

\*2 Adjust the Brightness when you are using the monitor in a dark room and feel the screen is too bright. There is also a "Night Mode" function that allows you to adjust the brightness in 3 levels according to your preference. See page 28.

\*3 Disabled when "AMD FreeSync" is activated. Available when the refresh rate is 75Hz or higher. 100Hz is recommended.

## Direct

You can skip the Menu items and directly display an option setting screen by using the following button operations.

- Eco : Press the **i** Button for 3 seconds while no Menu is displayed.
- Black Tuner / MBR / AMD FreeSync : Press the **i** Button while no Menu is displayed and select the appropriate menu.

### ■ Function Correlation Matrix

Active item \ Selected item	Picture Adjust			Color Settings	Image Adjust
	Adv.Contrast	Eco	MBR	Blue Light Reducer	i-Style Color Standard Sport Game FPS Game Strategy Game Text
Contrast	–	✓	✓	✓	–
Brightness	–	–	–	✓	–
Overdrive	✓	✓	–	✓	–
Adv. Contrast	–	✓	–	–	–
Eco	✓	–	–	–	–
Black Tuner	✓	✓	–	✓	–
MBR	–	–	–	–	–
AMD FreeSync	✓	✓	✓	✓	✓

✓ : Available

– : Not available





## Input Select

Direct

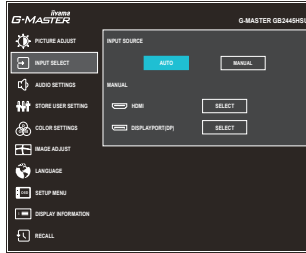

Adjustment Item	Option		
Input Source	Auto	Searches for an available input source and selects automatically.	
	Manual	HDMI	Selects the Digital (HDMI) input.
DisplayPort(DP)		Selects the Digital (DisplayPort) input.	

**NOTE** “Auto” function enables automatic selection of the input sources available. The input source from the computer in standby mode can not be selected. If you manually select one of the input sources, the other source is not automatically selected.

## Direct



You can skip the Menu items and directly display an option setting screen by using the following button operations.

- Input Select : Press the INPUT Button while no Menu is displayed.



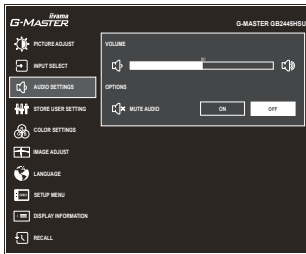

## Audio Settings



Adjustment Item	Problem / Option	Button to Press
Volume <b>Direct</b>	Too soft Too loud	 
Mute Audio <b>Direct</b>	On	Turns off the sound temporarily.
	Off	Returns the sound volume to the previous level.

### Direct

You can skip the Menu items and directly display an option setting screen by using the following button operations.

- Volume : Press the  Button while no Menu is displayed.
- Mute Audio : Press the  Button for 3 seconds while no Menu is displayed.



## Store User Setting



### Adjustment Item

### Option

User Modes

User Mode 1	Saves the settings of the screen adjustment.
User Mode 2	Saves the settings of the screen adjustment.
User Mode 3	Saves the settings of the screen adjustment.





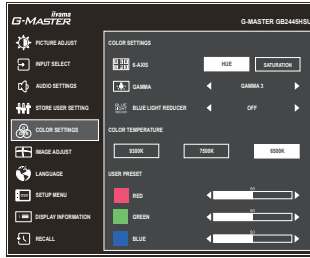

**NOTE** The monitor memorizes your customized settings below. Those settings can be invoked from “i-Style Color” menu of “Image Adjust” later.

Contrast, Brightness, Overdrive, Adv. Contrast, Eco, Black Tuner, Color Saturation, Volume, Mute Audio, Gamma, Color Temperature, User Preset, Sharp and Soft, Video Mode Adjust



# Color Settings



Adjustment Item	Problem / Option		Button to Press
6-Axis *	Hue	Red	Too weak  Too strong 
		Yellow	
Green			
Cyan			
Blue			
Magenta			
Saturation	Red	Too weak  Too strong 	
	Yellow		
	Green		
	Cyan		
	Blue		
	Magenta		
Gamma	Gamma 1		
	Gamma 2		
	Gamma 3		
Blue Light Reducer *	Off	Typical	
	Mode 1	Blue light is reduced.	
	Mode 2	Blue light is reduced more than Mode 1.	
	Mode 3	Blue light is reduced more than Mode 2.	
Color Temperature	9300K	Cool color	
	7500K	Normal color	
	6500K	Warm color	
User Preset	Red	Too weak  Too strong 	
	Green		
	Blue		

\* Disabled when "i-Style Color" is activated.

# Image Adjust



Adjustment Item	Option	Button to Press
i-Style Color * <sup>1</sup>	Off	The i-Style Color function is turned off.
	Standard	For general windows environment and monitor default setting
	Sport Game	For Sports game environment
	FPS Game	For FPS game environment
	Strategy Game	For Strategy game environment
	Text	For text editing and viewing in a word processing environment
	User Mode 1	Applies customized monitor settings.
	User Mode 2	Applies customized monitor settings.
	User Mode 3	Applies customized monitor settings.
Sharp and Soft	1 2 3 4 5 6 You can change the picture quality from 1 to 6 (sharp to soft). Press the ► Button to change the picture quality in numerical order. Press the ◀ Button to change the picture quality in reverse numerical order.	
RGB Range	Auto	Automatically selects color scale signal.
	Full	For full-range color scale signal
	Limited	For limited color scale signal
Video Mode Adjust	Full	Expansion display
	Aspect * <sup>2</sup>	Expansion display of Aspect

\*<sup>1</sup> Disabled when “Blue Light Reducer” is activated.

\*<sup>2</sup> Disabled with 16:9 resolution.



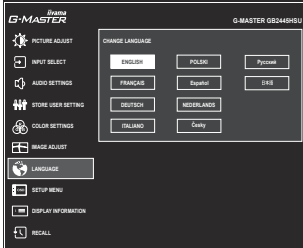



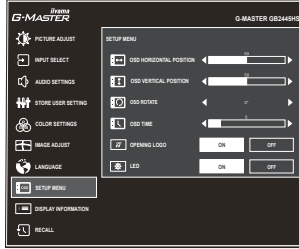

# Language



Adjustment Item	Option			
Language	English	English	Español	Spanish
	Français	French	Nederlands	Dutch
	Deutsch	German	Česky	Czech
	Italiano	Italian	Русский	Russian
	Polski	Polish	日本語	Japanese

## Setup Menu



Adjustment Item	Problem / Option	Button to Press
OSD Horizontal Position	OSD is too left OSD is too right	 
OSD Vertical Position	OSD is too high OSD is too low	 
OSD Rotate *	Rotates the OSD. 0° (Normal) / +90° (Rotate right) / -90° (Rotate left)	 
OSD Time	You can set the OSD display duration time between 5 and 30 seconds.	 
Opening Logo	On	G-MASTER Logo is displayed when the monitor is turned on.
	Off	G-MASTER Logo is not displayed when the monitor is turned on.
LED	On	The Power Indicator is turned On.
	Off	The Power Indicator is turned Off.
<p><b>NOTE</b> Turn Off the Power Indicator when you are bothered by the light.</p>		

\* For **G-MASTER GB244HSU, GB2745HSU, GB2745QSU, GB2455HSU, GB2755HSU, GB2755QSU**

**Display Information**

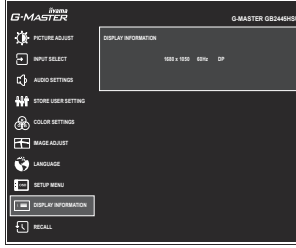

Displays information regarding the current input signal coming from the graphic card in your computer.

**NOTE** See your graphic card user guide for more information about changing the resolution and refresh.

**Recall**



Adjustment Item	Option
Recall	Factory-preset data is restored.



## Direct

- Night Mode : Press the **i** Button while no Menu is displayed and select the appropriate menu.

Adjustment Item	Option	
 Night Mode	Off	Normal
	Mode 1	Brightness is reduced.
	Mode 2	Brightness is reduced more than Mode 1.
	Mode 3	Brightness is reduced more than Mode 2.

## ● Lock Mode

### <OSD Menu>

1. The OSD lock will be activated by pressing the MENU Button for 10 seconds. If you try to access the OSD by pressing any of the buttons, message "OSD LOCKED" will appear on the screen.
2. The OSD lock will be deactivated by pressing the MENU Button again for 10 seconds.

### <Power Button>

1. The Power Button lock will be activated by pressing the EXIT Button for 10 seconds. Locking the Power Button means that won't be able to turn off the Monitor while the Power Button is locked. If you press the Power Button, message "POWER BUTTON LOCKED" will appear on the screen.
2. The Power Button lock will be deactivated by pressing the EXIT Button again for 10 seconds.

## STANDBY FEATURE

This product features the standby function. When activated, it automatically reduces unnecessary power consumption of the monitor when your computer is not in use.

There is a standby step the monitor takes as described below. The standby function, including any timer settings is configured by the operating system. Check your operating system manual for information on how this can be configured.

### ■ Standby Mode

When the video signal from the computer is off, the monitor enters into Standby Mode which reduces the power consumption to less than 0.5W\*. The screen becomes dark, and the power indicator turns to orange. From Standby Mode, the image reappears in several seconds when either the keyboard or the mouse are touched again.

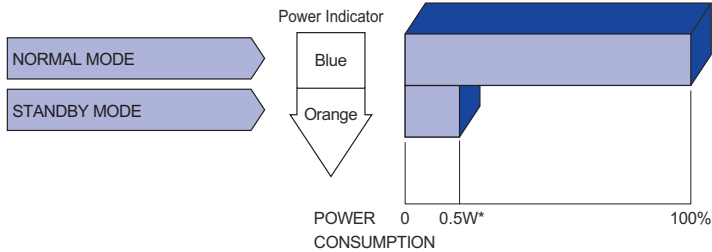

\* When the USB devices are not connected.

# TROUBLE SHOOTING

If the monitor fails to operate correctly, please follow the steps below for a possible solution.

1. Perform the adjustments described in OPERATING THE MONITOR, depending on the problem you have. If the monitor does not get a picture, skip to 2.
2. Consult the following items if you cannot find an appropriate adjustment item in OPERATING THE MONITOR or if the problem persists.
3. If you are experiencing a problem which is not described below or you cannot correct the problem, discontinue using the monitor and contact your dealer or iiyama service center for further assistance.

## Problem

## Check

- ① The picture does not appear.

(Power indicator does not light up.)

(Power indicator is blue.)

(Power indicator is orange.)

- ② The screen is not synchronized.

- ③ The screen position is not in the center.

- ④ The screen is too bright or too dark.

- ⑤ The screen is shaking.

- ⑥ No sound.

- ⑦ The sound is too loud or too quiet.

The Power Cable is firmly seated in the socket.

The Power Button is turned ON.

The AC socket is live. Please check with another piece of equipment.

If the blank screen saver is in active mode, touch the keyboard or the mouse.

Increase the Contrast and/or Brightness.

The computer is ON.

The Signal Cable is properly connected.

The signal timing of the computer is within the specification of the monitor.

If the monitor is in standby mode, touch the keyboard or the mouse.

The computer is ON.

The Signal Cable is properly connected.

The signal timing of the computer is within the specification of the monitor.

The Signal Cable is properly connected.

The signal timing of the computer is within the specification of the monitor.

The signal timing of the computer is within the specification of the monitor.

The video output level of the computer is within the specification of the monitor.

The power voltage is within the specification of the monitor.

The signal timing of the computer is within the specification of the monitor.

The audio equipment (computer etc.) is ON.

The Volume is turned up.

The Mute is OFF.

The audio output level of the audio equipment is within the specification of the monitor.

The audio output level of the audio equipment is within the specification of the monitor.

# RECYCLING INFORMATION

For better environment protection please don't dispose your monitor.  
Please visit our web site: <https://iiyama.com> for monitor recycling.

# APPENDIX

Design and specifications are subject to change without prior notice.

## SPECIFICATIONS : G-MASTER GB2445HSU-B1, G-MASTER GB2455HSU-B1

ENGLISH

		G-MASTER GB2445HSU-B1	G-MASTER GB2455HSU-B1
Size Category		24"	
LCD Panel	Panel technology	IPS (In-Plane-Switching)	VA
	Size	Diagonal: 23.8" (60.5cm)	
	Pixel pitch	0.275mm H × 0.275mm V	
	Brightness	250cd/m <sup>2</sup> (Typical)	
		160cd/m <sup>2</sup> (Default / Energy Saving)	155cd/m <sup>2</sup> (Default / Energy Saving)
	Contrast ratio	1300 : 1 (Typical)	
		4000 : 1 (Typical)	
	Viewable angle		Right / Left: 89 degrees each, Up / Down: 89 degrees each (Typical)
MPRT		1ms	
Display Colors		Approx. 16.7M	
Sync Frequency	HDMI	FreeSync-On: Horizontal: 30.0-110.0kHz, Vertical: 48-100Hz FreeSync-Off: Horizontal: 30.0-110.0kHz, Vertical: 55-100Hz	
	DisplayPort	FreeSync-On: Horizontal: 110.0-110.0kHz, Vertical: 48-100Hz FreeSync-Off: Horizontal: 110.0-110.0kHz, Vertical: 55-100Hz	
Native Resolution		1920 × 1080, 2.1 MegaPixels	
Support Max. Resolution		1920 × 1080 100Hz	
Input Connector		HDMI ×1, DisplayPort ×1	
Input Video Signal		HDMI, DisplayPort	
USB Standard		USB2.0 (DC5V, 500mA)	
Number of USB Ports		1 Upstream: Type-B	
Connector Shape		2 Downstream: Type-A	
Headphone Connector		ø 3.5mm mini jack (Stereo)	
Speakers		2W × 2 (Stereo speakers)	
Maximum Screen Size		527.0mm W × 296.5mm H / 20.7" W × 11.7" H	
Power Source		100-240VAC, 50/60Hz, 1.5A	
Power Consumption		18W typical *	19W typical *
		Standby mode: 0.5W maximum, Off mode: 0.3W maximum	
Dimensions		538.5 × 354.0 - 504.0 × 171.0mm / 21.2 × 13.9 - 19.8 × 6.7" (W×H×D)	
Net Weight		4.4kg / 9.7lbs	4.3kg / 9.5lbs
Height Adjustment Range		150mm	
Angle		Tilt: Upward: 23 degrees, Downward: 5 degrees Swivel: Left / Right: 45 degrees each Rotation: Clockwise / Counterclockwise: 90 degrees each	
Environmental Considerations		Operating: Temperature	5 to 35°C / 41 to 95°F
		Humidity	10 to 90% (No condensation)
Storage:		Temperature	-20 to 60°C / -4 to 140°F
		Humidity	10 to 90% (No condensation)
Approvals		CE, UKCA, TÜV-Bauart, EAC, VCCI, PSE	

**NOTE** \* When the USB devices are not connected.

# SPECIFICATIONS : G-MASTER GB2745HSU-B1, G-MASTER GB2755HSU-B1

		G-MASTER GB2745HSU-B1	G-MASTER GB2755HSU-B1
Size Category		27"	
LCD Panel	Panel technology	IPS (In-Plane-Switching)	VA
	Size	Diagonal: 27" (68.5cm)	
	Pixel pitch	0.311mm H × 0.311mm V	
	Brightness	250cd/m <sup>2</sup> (Typical)	
		170cd/m <sup>2</sup> (Default / Energy Saving)	160cd/m <sup>2</sup> (Default / Energy Saving)
	Contrast ratio	1000 : 1 (Typical)	4000 : 1 (Typical)
		Adv. Contrast Function Available	
Viewable angle	Right / Left: 89 degrees each, Up / Down: 89 degrees each (Typical)		
MPRT	1ms		
Display Colors		Approx. 16.7M	
Sync Frequency	HDMI	FreeSync-On: Horizontal: 30.0-110.0kHz, Vertical: 48-100Hz FreeSync-Off: Horizontal: 30.0-110.0kHz, Vertical: 55-100Hz	
	DisplayPort	FreeSync-On: Horizontal: 110.0-110.0kHz, Vertical: 48-100Hz FreeSync-Off: Horizontal: 110.0-110.0kHz, Vertical: 55-100Hz	
Native Resolution		1920 × 1080, 2.1 MegaPixels	
Support Max. Resolution		1920 × 1080 100Hz	
Input Connector		HDMI ×1, DisplayPort ×1	
Input Video Signal		HDMI, DisplayPort	
USB Standard		USB2.0 (DC5V, 500mA)	
Number of USB Ports Connector Shape		1 Upstream: Type-B 2 Downstream: Type-A	
Headphone Connector		ø 3.5mm mini jack (Stereo)	
Speakers		2W × 2 (Stereo speakers)	
Maximum Screen Size		596.7mm W × 335.7mm H / 23.5" W × 13.2" H	597.9mm W × 336.3mm H / 23.5" W × 13.2" H
Power Source		100-240VAC, 50/60Hz, 1.5A	
Power Consumption		22W typical *	21W typical *
		Standby mode: 0.5W maximum, Off mode: 0.3W maximum	
Dimensions		611.5 × 405.5 - 555.5 × 214.0mm / 24.1 × 16.0 - 21.9 × 8.4" (W×H×D)	613.5 × 405.5 - 555.5 × 214.0mm / 24.2 × 16.0 - 21.9 × 8.4" (W×H×D)
Net Weight		5.2kg / 11.5lbs	5.1kg / 11.2lbs
Height Adjustment Range		150mm	
Angle		Tilt: Upward: 23 degrees, Downward: 5 degrees Swivel: Left / Right: 45 degrees each Rotation: Clockwise / Counterclockwise: 90 degrees each	
Environmental Considerations		Operating: Temperature 5 to 35°C / 41 to 95°F Humidity 10 to 90% (No condensation) Storage: Temperature -20 to 60°C / -4 to 140°F Humidity 10 to 90% (No condensation)	
Approvals		CE, UKCA, TÜV-Bauart, EAC, VCCI, PSE	

**NOTE** \* When the USB devices are not connected.

## SPECIFICATIONS : G-MASTER GB2745QSU-B1, G-MASTER GB2755QSU-B1

ENGLISH

		G-MASTER GB2745QSU-B1	G-MASTER GB2755QSU-B1	
Size Category		27"		
LCD Panel	Panel technology	IPS (In-Plane-Switching)	VA	
	Size	Diagonal: 27" (68.5cm)		
	Pixel pitch	0.233mm H × 0.233mm V		
	Brightness	250cd/m <sup>2</sup> (Typical), 165cd/m <sup>2</sup> (Default / Energy Saving)		
	Contrast ratio	1300 : 1 (Typical)	4000 : 1 (Typical)	
		Adv. Contrast Function Available		
	Viewable angle	Right / Left: 89 degrees each, Up / Down: 89 degrees each (Typical)		
MPRT	1ms			
Display Colors		Approx. 16.7M		
Sync Frequency	HDMI	FreeSync-On: Horizontal: 30.0-151.0kHz, Vertical: 48-100Hz FreeSync-Off: Horizontal: 30.0-151.0kHz, Vertical: 55-100Hz		
	DisplayPort	FreeSync-On: Horizontal: 151.0-151.0kHz, Vertical: 48-100Hz FreeSync-Off: Horizontal: 151.0-151.0kHz, Vertical: 55-100Hz		
Native Resolution		2560 × 1440, 3.7 MegaPixels		
Support Max. Resolution		2560 × 1440 100Hz		
Input Connector		HDMI ×1, DisplayPort ×1		
Input Video Signal		HDMI, DisplayPort		
USB Standard		USB3.2 Gen 1 (5Gbps, DC5V, 900mA)		
Number of USB Ports		1 Upstream: Type-B		
Connector Shape		2 Downstream: Type-A		
Headphone Connector		ø 3.5mm mini jack (Stereo)		
Speakers		2W × 2 (Stereo speakers)		
Maximum Screen Size		596.7mm W × 335.7mm H / 23.5" W × 13.2" H		
Power Source		100-240VAC, 50/60Hz, 1.5A		
Power Consumption		21W typical *	24W typical *	
		Standby mode: 0.5W maximum, Off mode: 0.3W maximum		
Dimensions		611.5 × 405.5 - 555.5 × 214.0mm / 24.1 × 16.0 - 21.9 × 8.4" (W×H×D)	613.5 × 405.5 - 555.5 × 214.0mm / 24.2 × 16.0 - 21.9 × 8.4" (W×H×D)	
Net Weight		5.5kg / 12.1lbs	5.4kg / 11.9lbs	
Height Adjustment Range		150mm		
Angle		Tilt: Upward: 23 degrees, Downward: 5 degrees Swivel: Left / Right: 45 degrees each Rotation: Clockwise / Counterclockwise: 90 degrees each		
Environmental Considerations		Operating: Temperature 5 to 35°C / 41 to 95°F Humidity 10 to 90% (No condensation) Storage: Temperature -20 to 60°C / -4 to 140°F Humidity 10 to 90% (No condensation)		
Approvals		CE, UKCA, TÜV-Bauart, EAC, VCCI, PSE		

**NOTE** \* When the USB devices are not connected.

## SPECIFICATIONS : G-MASTER G2445HSU-B1, G-MASTER G2455HSU-B1

		G-MASTER G2445HSU-B1	G-MASTER G2455HSU-B1
Size Category		24"	
LCD Panel	Panel technology	IPS (In-Plane-Switching)	VA
	Size	Diagonal: 23.8" (60.5cm)	
	Pixel pitch	0.275mm H × 0.275mm V	
	Brightness	250cd/m <sup>2</sup> (Typical)	
		160cd/m <sup>2</sup> (Default / Energy Saving)	155cd/m <sup>2</sup> (Default / Energy Saving)
	Contrast ratio	1300 : 1 (Typical)	4000 : 1 (Typical)
		Adv. Contrast Function Available	
Viewable angle	Right / Left: 89 degrees each, Up / Down: 89 degrees each (Typical)		
MPRT	1ms		
Display Colors		Approx. 16.7M	
Sync Frequency	HDMI	FreeSync-On: Horizontal: 30.0-110.0kHz, Vertical: 48-100Hz FreeSync-Off: Horizontal: 30.0-110.0kHz, Vertical: 55-100Hz	
	DisplayPort	FreeSync-On: Horizontal: 110.0-110.0kHz, Vertical: 48-100Hz FreeSync-Off: Horizontal: 110.0-110.0kHz, Vertical: 55-100Hz	
Native Resolution		1920 × 1080, 2.1 MegaPixels	
Support Max. Resolution		1920 × 1080 100Hz	
Input Connector		HDMI ×1, DisplayPort ×1	
Input Video Signal		HDMI, DisplayPort	
USB Standard		USB2.0 (DC5V, 500mA)	
Number of USB Ports Connector Shape		1 Upstream: Type-B 2 Downstream: Type-A	
Headphone Connector		ø 3.5mm mini jack (Stereo)	
Speakers		2W × 2 (Stereo speakers)	
Maximum Screen Size		527.0mm W × 296.5mm H / 20.7" W × 11.7" H	
Power Source		100-240VAC, 50/60Hz, 1.5A	
Power Consumption		18W typical *	19W typical *
		Standby mode: 0.5W maximum, Off mode: 0.3W maximum	
Dimensions		538.5 × 397.0 × 192.5mm / 21.2 × 15.6 × 7.6" (W×H×D)	
Net Weight		3.0kg / 6.6lbs	3.0kg / 6.6lbs
Tilt Angle		Upward: 22 degrees, Downward: 4 degrees	
Environmental Considerations		Operating: Temperature 5 to 35°C / 41 to 95°F Humidity 10 to 90% (No condensation)	
		Storage: Temperature -20 to 60°C / -4 to 140°F Humidity 10 to 90% (No condensation)	
Approvals		CE, UKCA, TÜV-Bauart, EAC, VCCI, PSE	

**NOTE** \* When the USB devices are not connected.



## SPECIFICATIONS : G-MASTER G2745HSU-B1, G-MASTER G2755HSU-B1

		G-MASTER G2745HSU-B1	G-MASTER G2755HSU-B1
Size Category		27"	
LCD Panel	Panel technology	IPS (In-Plane-Switching)	VA
	Size	Diagonal: 27" (68.5cm)	
	Pixel pitch	0.311mm H × 0.311mm V	
	Brightness	250cd/m <sup>2</sup> (Typical)	
		170cd/m <sup>2</sup> (Default / Energy Saving)	160cd/m <sup>2</sup> (Default / Energy Saving)
	Contrast ratio	1000 : 1 (Typical)	4000 : 1 (Typical)
		Adv. Contrast Function Available	
	Viewable angle	Right / Left: 89 degrees each, Up / Down: 89 degrees each (Typical)	
MPRT	1ms		
Display Colors		Approx. 16.7M	
Sync Frequency	HDMI	FreeSync-On: Horizontal: 30.0-110.0kHz, Vertical: 48-100Hz FreeSync-Off: Horizontal: 30.0-110.0kHz, Vertical: 55-100Hz	
	DisplayPort	FreeSync-On: Horizontal: 110.0-110.0kHz, Vertical: 48-100Hz FreeSync-Off: Horizontal: 110.0-110.0kHz, Vertical: 55-100Hz	
Native Resolution		1920 × 1080, 2.1 MegaPixels	
Support Max. Resolution		1920 × 1080 100Hz	
Input Connector		HDMI ×1, DisplayPort ×1	
Input Video Signal		HDMI, DisplayPort	
USB Standard		USB2.0 (DC5V, 500mA)	
Number of USB Ports Connector Shape		1 Upstream: Type-B 2 Downstream: Type-A	
Headphone Connector		ø 3.5mm mini jack (Stereo)	
Speakers		2W × 2 (Stereo speakers)	
Maximum Screen Size		596.7mm W × 335.7mm H / 23.5" W × 13.2" H	597.9mm W × 336.3mm H / 23.5" W × 13.2" H
Power Source		100-240VAC, 50/60Hz, 1.5A	
Power Consumption		22W typical *	21W typical *
		Standby mode: 0.5W maximum, Off mode: 0.3W maximum	
Dimensions		611.5 × 434.0 × 192.5mm / 24.1 × 17.1 × 7.6" (W×H×D)	613.5 × 434.0 × 192.5mm / 24.2 × 17.1 × 7.6" (W×H×D)
Net Weight		3.9kg / 8.6lbs	3.7kg / 8.2lbs
Tilt Angle		Upward: 22 degrees, Downward: 4 degrees	
Environmental Considerations		Operating: Temperature	5 to 35°C / 41 to 95°F
		Humidity	10 to 90% (No condensation)
		Storage: Temperature	-20 to 60°C / -4 to 140°F
		Humidity	10 to 90% (No condensation)
Approvals		CE, UKCA, TÜV-Bauart, EAC, VCCI, PSE	

**NOTE** \* When the USB devices are not connected.

## SPECIFICATIONS : G-MASTER G2745QSU-B1, G-MASTER G2755QSU-B1

		G-MASTER G2745QSU-B1	G-MASTER G2755QSU-B1	
Size Category		27"		
LCD Panel	Panel technology	IPS (In-Plane-Switching)	VA	
	Size	Diagonal: 27" (68.5cm)		
	Pixel pitch	0.233mm H × 0.233mm V		
	Brightness	250cd/m <sup>2</sup> (Typical), 165cd/m <sup>2</sup> (Default / Energy Saving)		
	Contrast ratio	1300 : 1 (Typical)	4000 : 1 (Typical)	
		Adv. Contrast Function Available		
	Viewable angle	Right / Left: 89 degrees each, Up / Down: 89 degrees each (Typical)		
MPRT	1ms			
Display Colors		Approx. 16.7M		
Sync Frequency	HDMI	FreeSync-On: Horizontal: 30.0-151.0kHz, Vertical: 48-100Hz FreeSync-Off: Horizontal: 30.0-151.0kHz, Vertical: 55-100Hz		
	DisplayPort	FreeSync-On: Horizontal: 151.0-151.0kHz, Vertical: 48-100Hz FreeSync-Off: Horizontal: 151.0-151.0kHz, Vertical: 55-100Hz		
Native Resolution		2560 × 1440, 3.7 MegaPixels		
Support Max. Resolution		2560 × 1440 100Hz		
Input Connector		HDMI ×1, DisplayPort ×1		
Input Video Signal		HDMI, DisplayPort		
USB Standard		USB3.2 Gen 1 (5Gbps, DC5V, 900mA)		
Number of USB Ports		1 Upstream: Type-B		
Connector Shape		2 Downstream: Type-A		
Headphone Connector		ø 3.5mm mini jack (Stereo)		
Speakers		2W × 2 (Stereo speakers)		
Maximum Screen Size		596.7mm W × 335.7mm H / 23.5" W × 13.2" H		
Power Source		100-240VAC, 50/60Hz, 1.5A		
Power Consumption		21W typical *	24W typical *	
		Standby mode: 0.5W maximum, Off mode: 0.3W maximum		
Dimensions		611.5 × 434.0 × 192.5mm / 24.1 × 17.1 × 7.6" (W×H×D)	613.5 × 434.0 × 192.5mm / 24.2 × 17.1 × 7.6" (W×H×D)	
Net Weight		4.2kg / 9.3lbs	4.0kg / 8.8lbs	
Tilt Angle		Upward: 22 degrees, Downward: 4 degrees		
Environmental Considerations		Operating: Temperature	5 to 35°C / 41 to 95°F	
		Humidity	10 to 90% (No condensation)	
		Storage: Temperature	-20 to 60°C / -4 to 140°F	
		Humidity	10 to 90% (No condensation)	
Approvals		CE, UKCA, TÜV-Bauart, EAC, VCCI, PSE		

**NOTE** \* When the USB devices are not connected.

**DIMENSIONS : G-MASTER GB2445HSU, G-MASTER GB2455HSU**

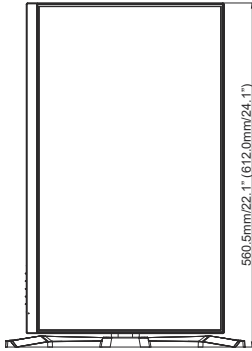
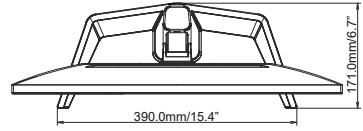
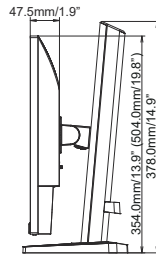
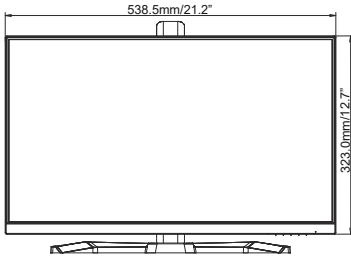

( ) : Maximum adjustment range

**DIMENSIONS : G-MASTER GB2745HSU, G-MASTER GB2745QSU**

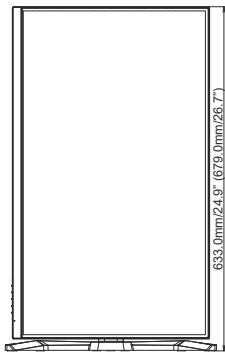
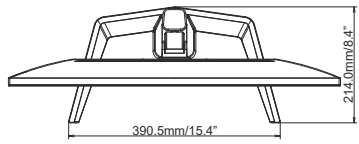
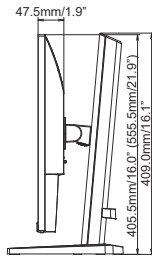
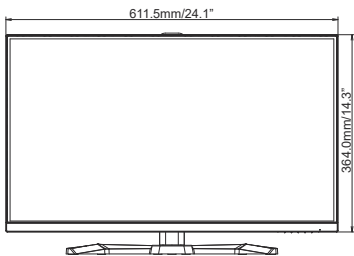

( ) : Maximum adjustment range

**DIMENSIONS : G-MASTER GB2755HSU, G-MASTER GB2755QSU**

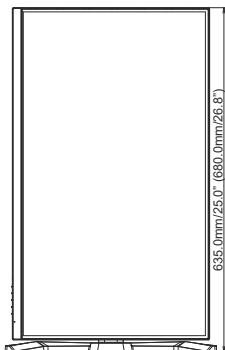
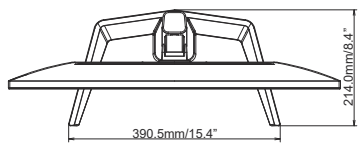
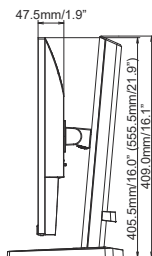
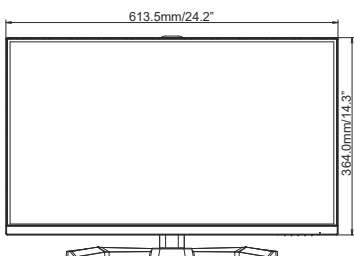

( ) : Maximum adjustment range

**DIMENSIONS : G-MASTER G2445HSU, G-MASTER G2455HSU**

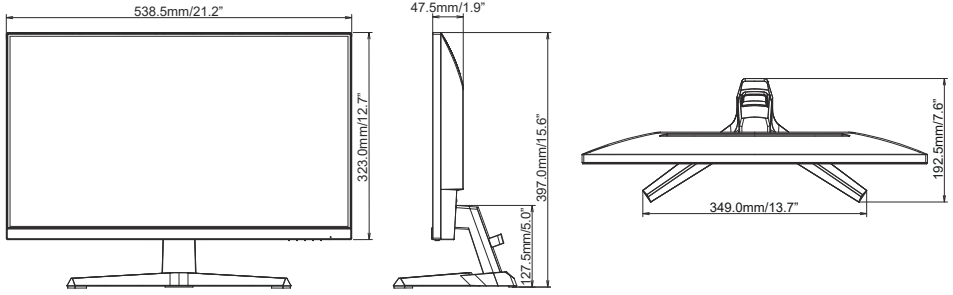

**DIMENSIONS : G-MASTER G2745HSU, G-MASTER G2745QSU**

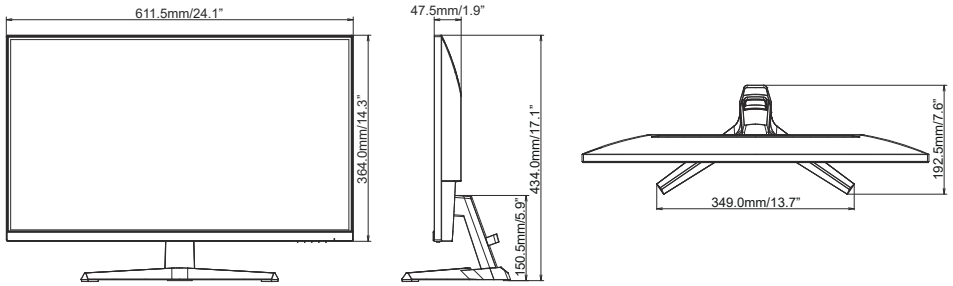

**DIMENSIONS : G-MASTER G2755HSU, G-MASTER G2755QSU**

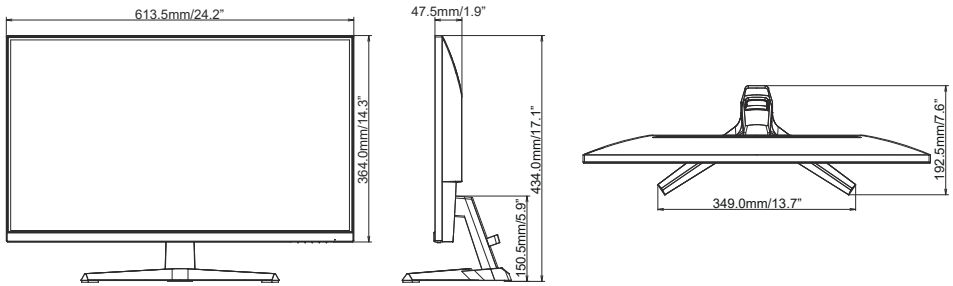

## COMPLIANT TIMING

Video Mode	Horizontal Frequency	Vertical Frequency	Dot Clock
800 × 600	37.879kHz	60.317Hz	40.000MHz
	46.875kHz	75.000Hz	49.500MHz
1024 × 768	48.363kHz	60.004Hz	65.000MHz
	60.023kHz	75.029Hz	78.750MHz
1280 × 1024	79.980kHz	75.020Hz	135.000MHz
1680 × 1050	65.290kHz	60.000Hz	146.250MHz
1920 × 1080	67.500kHz	60.000Hz	148.500MHz
	83.890kHz	74.970Hz	174.500MHz
	95.430kHz	84.910Hz	198.500MHz
	110.000kHz	100.000Hz	228.800MHz
2560 × 1440	89.520kHz	59.961Hz	312.250MHz
	111.788kHz	74.925Hz	298.470MHz
	150.849kHz	99.900Hz	398.242MHz
	150.918kHz	99.900Hz	410.500MHz

**NOTE** \*1 Only available for G-MASTER G(B)2445HSU, G(B)2745HSU, G(B)2455HSU, G(B)2755HSU.

\*2 Only available for G-MASTER G(B)2745QSU, G(B)2755QSU.

\*3 Available for DisplayPort input only.

\*4 Available for HDMI input only.