

# G435

SETUP GUIDE | GUIDE D'INSTALLATION





ENGLISH . . . . . 3  
FRANÇAIS . . . . . 12  
ESPAÑOL . . . . . 21  
PORTUGUÊS . . . . . 30

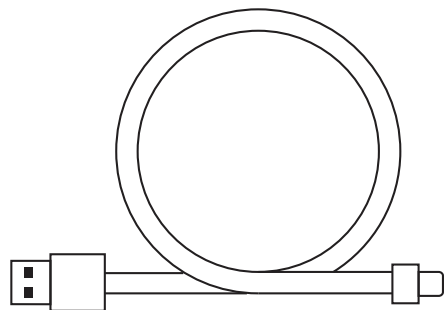
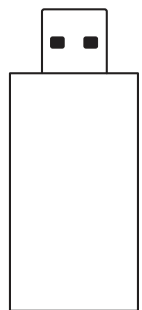

# LIGHTSPEED CONNECTION

Connect to your PC, Mac, PlayStation 5 or 4 with LIGHTSPEED Wireless Technology

- Insert receiver into the USB port of your device.

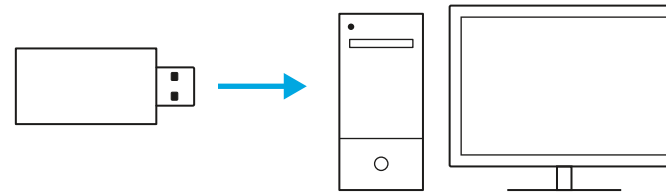

- Press the Power button for minimum 1.5 sec.

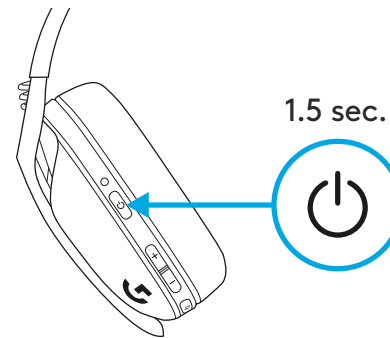

- The LED turns cyan once connected.

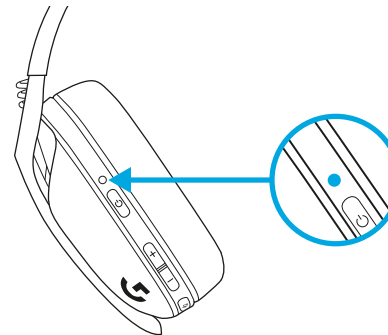

# BLUETOOTH CONNECTION

- Press 3 seconds or longer of the Power and Mute button.

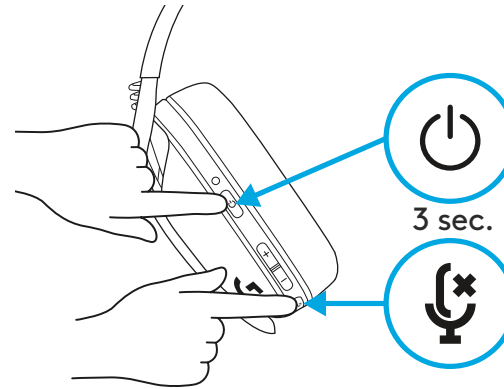

- LED will flash blue as it enters pairing mode.

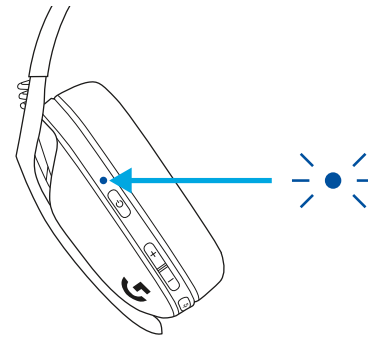

- Connect to your preferred device.

- G435 can connect to a single *bluetooth* device at a time.

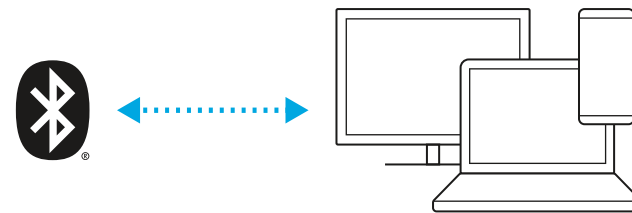

# SWITCH BETWEEN LIGHTSPEED AND BLUETOOTH

- Press 3 seconds or longer of the Mute button.

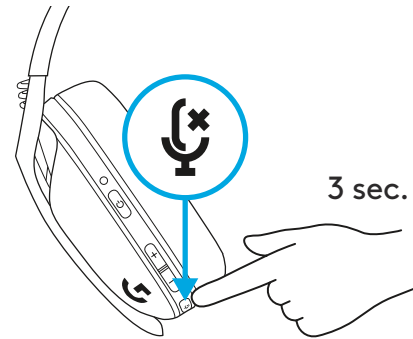

- Switch to LIGHTSPEED, LED will light cyan for 5 seconds.

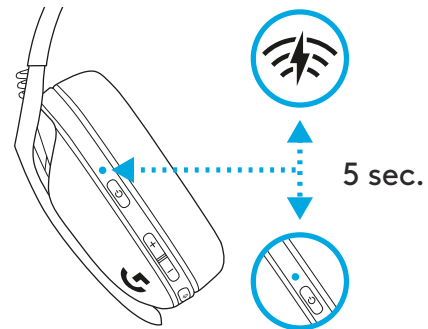

- Switch to Bluetooth, LED will light blue for 5 seconds.

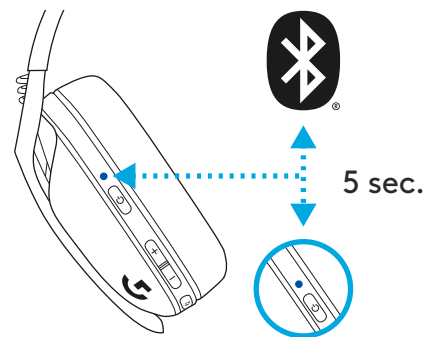

# POWER ON AND OFF

## Power ON

- Press the Power button for 1.5 seconds when the headset is OFF.

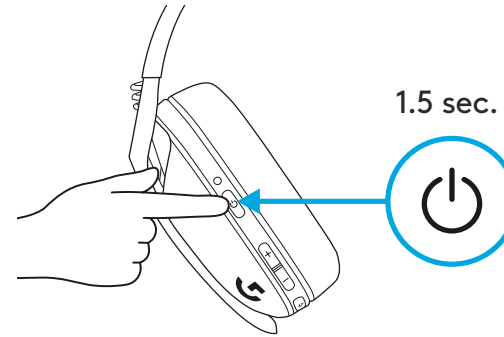

## Power OFF

- Press the Power button for 3 seconds when the headset is ON.

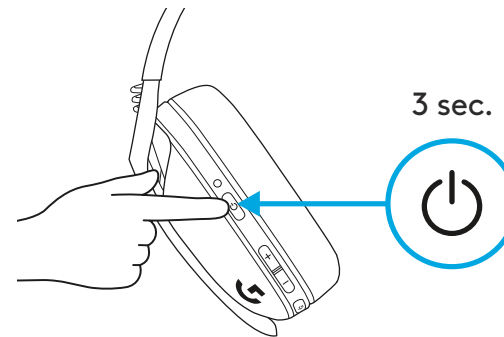

## Auto Shutoff

- After 30 minutes of inactivity.

# MUTE / UNMUTE AND MAX VOLUME

## MUTE / UNMUTE microphone

- Short press on the Mute button.

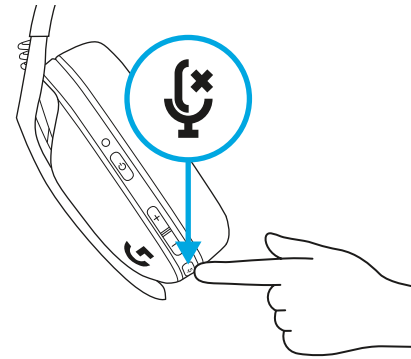

## Set Max Volume

- Set to 100 dB
  - Press 3 seconds or longer Mute button + Volume UP.
  - LED will flash orange 3 times.

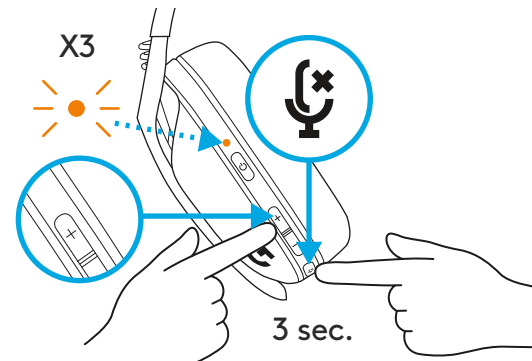

- Set to 85 dB
  - Press 3 seconds or longer Mute button + Volume DOWN.
  - LED will turn solid orange for 5 seconds.

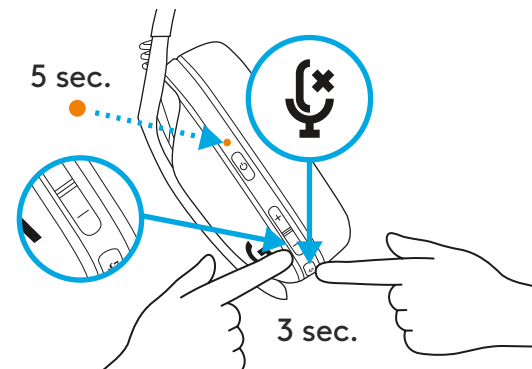

# BATTERY CHECK

- Single press Power button, when headset is ON
  - Battery 31% to 100% the LED will show **green** for 5 seconds.

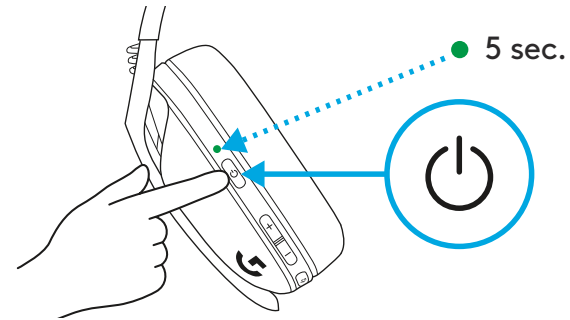

- Battery 15% to 30% the LED will show **red** for 5 seconds.

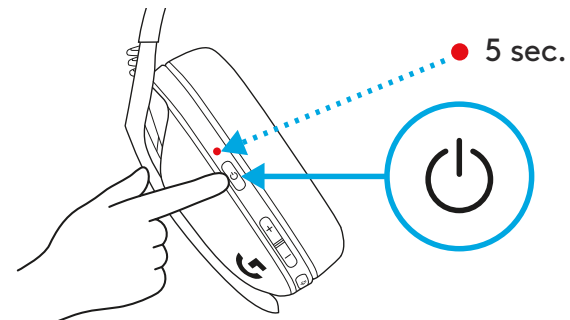

- Battery <15% the LED will flash **red** for 5 seconds.

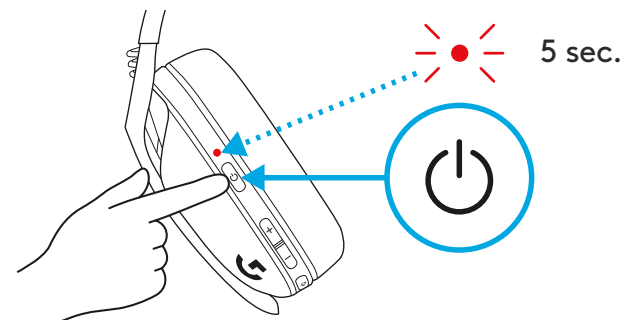



# SIDETONE

Sidetone lets you hear your voice while communicating with other people. It mirrors the experience of talking on a phone and allows you to adjust your speaking volume to a proper level.

- Enable Sidetone
  - Double press the Mute button and the LED will flash twice in **orange**.

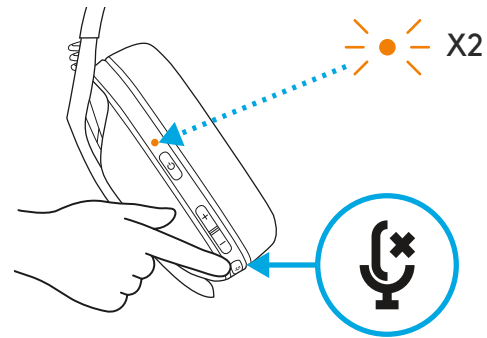

- Disable Sidetone
  - Double press the Mute button and the LED will flash once in **orange**.

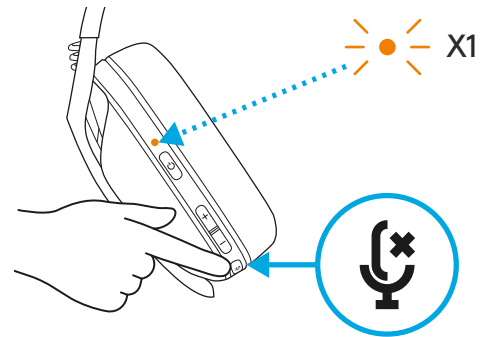

- Adjust Sidetone

- UP = Single press Mute button + Volume UP.

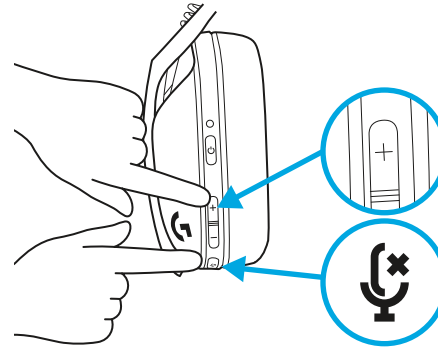

- DOWN = Single press Mute button + Volume DOWN.

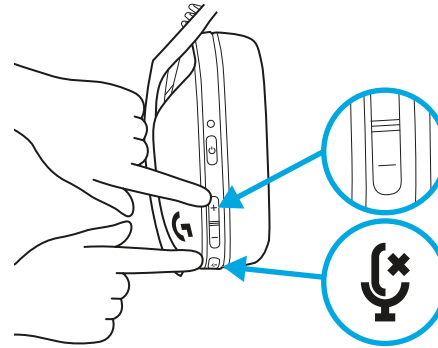

## SPARE PARTS

- Earpads
- Wireless USB Receiver
- Charging Cable

## RECYCLING

We encourage you to resell or donate working products. Otherwise, batteries, electronic and electrical equipment should not be disposed of with household waste. Wherever possible, they should be segregated and brought to an appropriate collection point to enable recycling and avoid potential impacts on the environment and human health. For more information, contact your local authorities or place of purchase, or visit [www.logitech.com/recycling](http://www.logitech.com/recycling)

## QUESTIONS?

[logitechG.com/support/G435](http://logitechG.com/support/G435)

## BATTERY REMOVAL

1

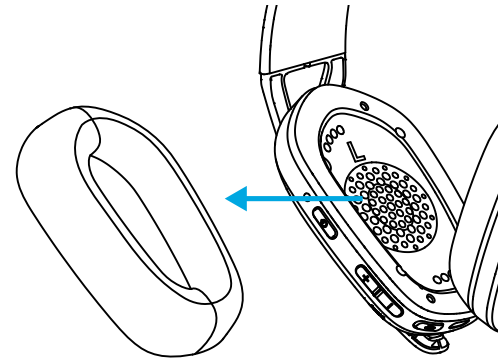

2

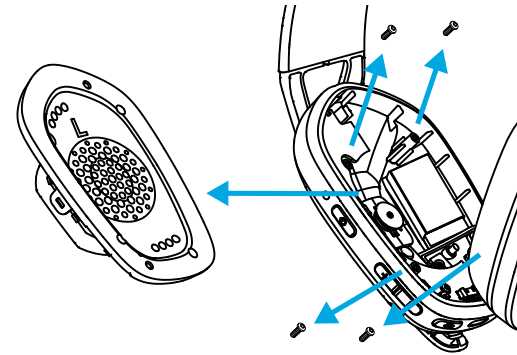

3

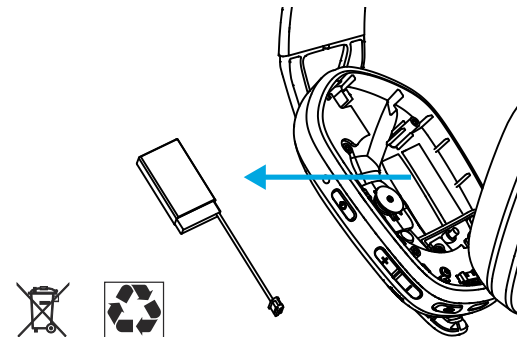

# CONNEXION LIGHTSPEED

Connectez-vous à votre PC, Mac, PlayStation 5 ou 4 avec la technologie sans fil LIGHTSPEED

– Insérez le récepteur dans le port USB de votre dispositif.

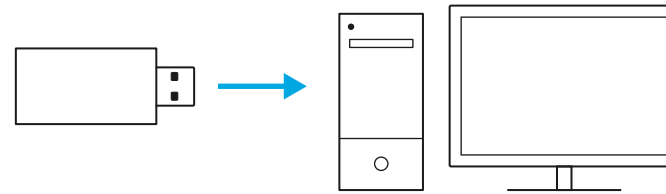

– Maintenez le bouton Marche/Arrêt enfoncé pendant au moins 1,5 seconde.

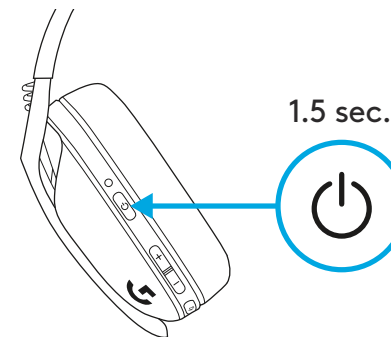

– Une fois la connexion effectuée, le témoin lumineux devient cyan.

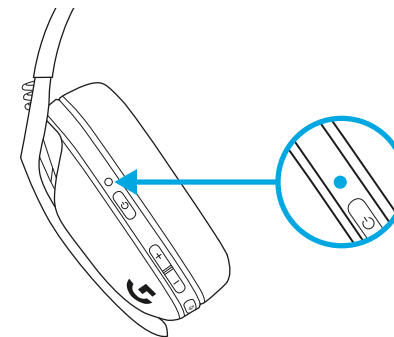

# CONNEXION *BLUETOOTH*

- Appuyez pendant au moins 3 secondes sur le bouton Marche/Arrêt et Sourdine.

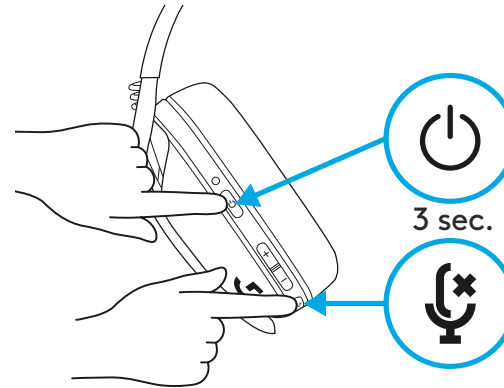

- Le témoin lumineux clignotera en **bleu** en entrant en mode de couplage.

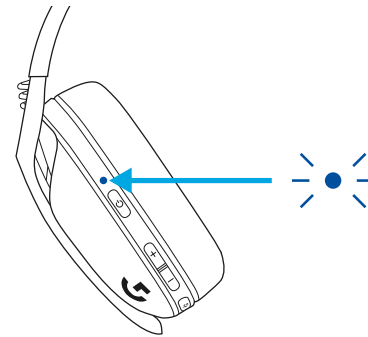

- Connectez-vous au dispositif de votre choix.

- G435 peut se connecter à un seul dispositif *Bluetooth* à la fois.

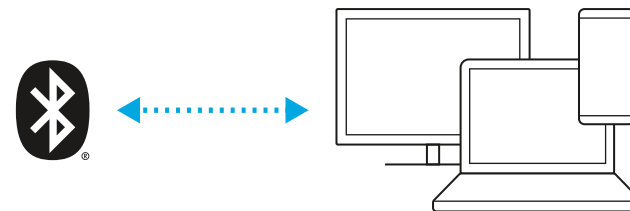

# BASCULEZ ENTRE LES TECHNOLOGIES LIGHTSPEED ET *BLUETOOTH*

- Appuyez pendant au moins 3 secondes sur le bouton Sourdine.

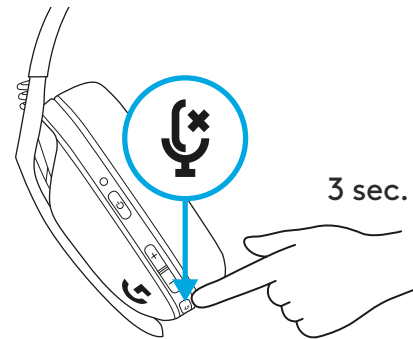

- En passant sur LIGHTSPEED, le voyant lumineux s'allumera en **cyan** pendant 5 secondes.

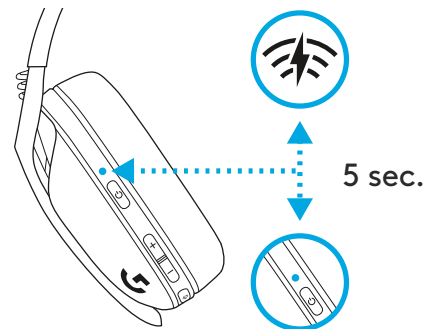

- En passant sur *Bluetooth*, le témoin lumineux s'allumera en **bleu** pendant 5 secondes.

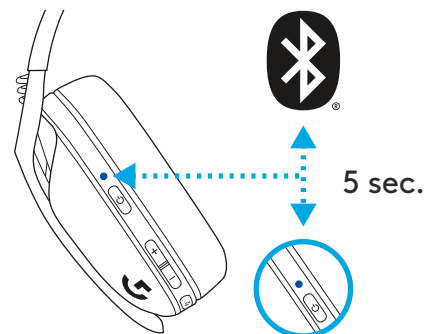

# MISE SOUS TENSION ET HORS TENSION

## Mise sous tension

- Appuyez sur le bouton Marche/Arrêt pendant 1,5 seconde lorsque le casque est hors tension.

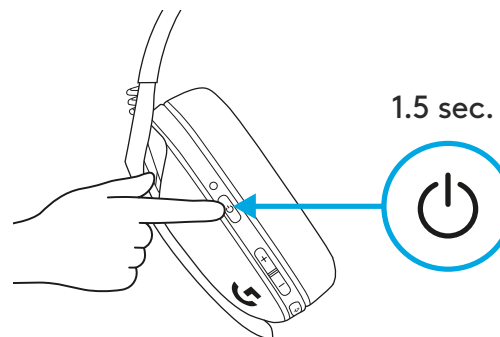

## Mise hors tension

- Appuyez sur le bouton Marche/Arrêt pendant 3 secondes lorsque le casque est sous tension.

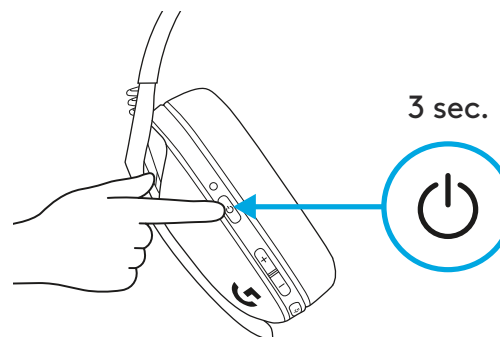

## Mise hors tension automatique

- Après 30 minutes d'inactivité.





# VÉRIFICATION DE LA BATTERIE

- Appuyez une fois sur le bouton Marche/Arrêt lorsque le casque est sous tension.
- Si le niveau de la batterie se situe entre 31 et 100%, le témoin lumineux s'allume en **vert** pendant 5 secondes.

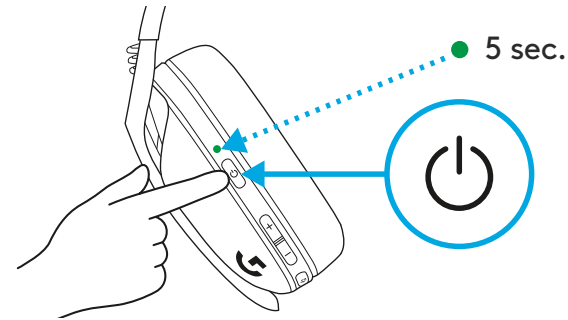

- Si le niveau de la batterie se situe entre 15 et 30%, le témoin lumineux s'allume en **rouge** pendant 5 secondes.

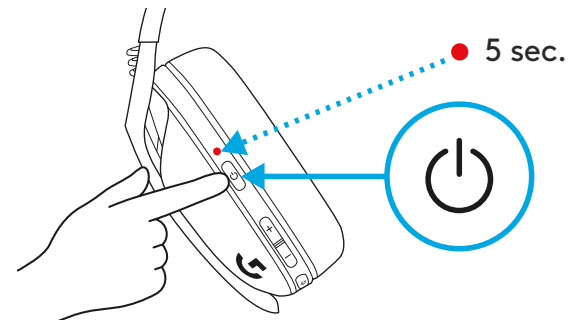

- Si le niveau de la batterie se situe en dessous de 15%, le témoin lumineux clignote en **rouge** pendant 5 secondes.

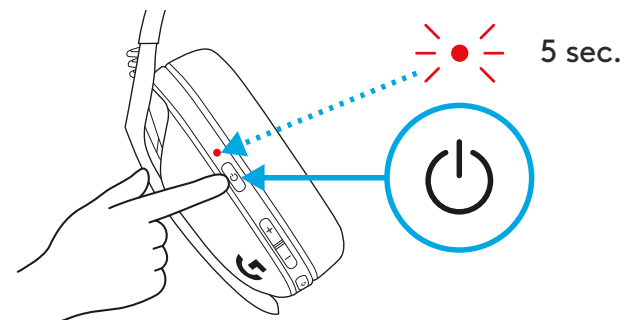

## EFFET LOCAL

L'effet local vous permet d'entendre votre voix pendant vos communications avec d'autres personnes. Tout comme pendant une communication téléphonique, vous pouvez ajuster le volume de votre voix à un niveau adéquat.

- Activer l'effet local
  - Appuyez deux fois sur le bouton Sourdine et le témoin lumineux clignotera deux fois en orange.

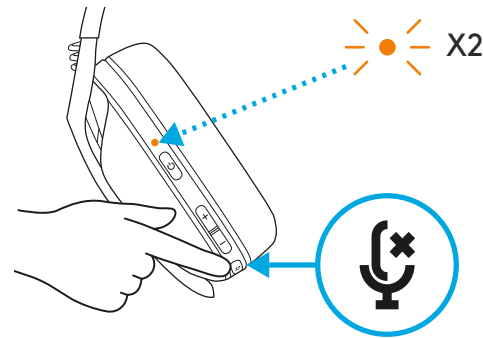

- Désactiver l'effet local
  - Appuyez deux fois sur le bouton Sourdine et le témoin lumineux clignotera une fois en orange.

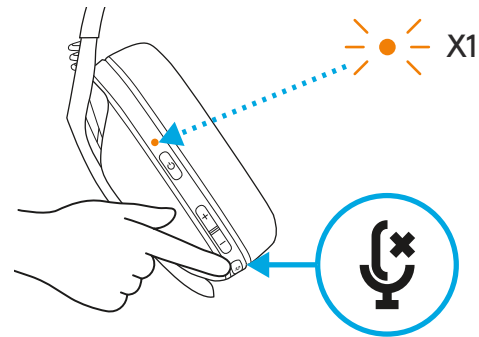

– Réglage de l'effet local

- PLUS = Appuyez une fois sur le bouton Sourdine et Volume+.

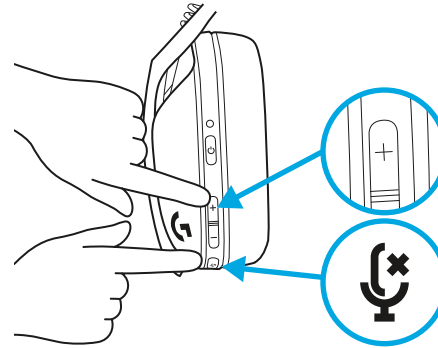

- MOINS = Appuyez une fois sur le bouton Sourdine et Volume-.

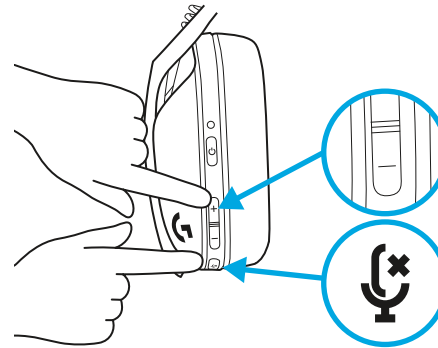

## PIÈCES DE RECHANGE

- Oreillettes
- Récepteur USB sans fil
- Câble de charge

## RECYCLAGE

Nous vous encourageons à revendre ou à donner les produits fonctionnels. Les piles ainsi que l'équipement électronique et électrique ne doivent pas être jetés avec les déchets ménagers. Dans la mesure du possible, ils doivent être triés et déposés dans un centre de collecte adéquat pour permettre leur recyclage et éviter tout impact potentiel sur l'environnement et la santé humaine. Pour en savoir plus, contactez les autorités locales ou le point de vente, ou rendez-vous sur le site [www.logitech.com/recycling](http://www.logitech.com/recycling)

## DES QUESTIONS?

[logitechG.com/support/G435](http://logitechG.com/support/G435)

## INSTRUCTIONS DE RETRAIT

1

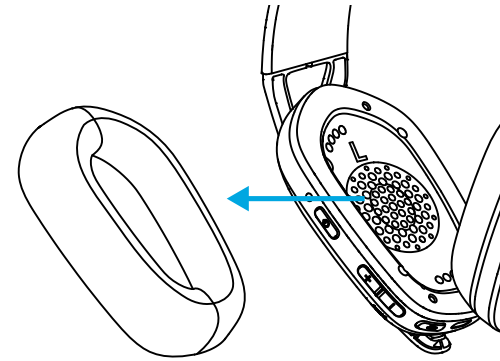

2

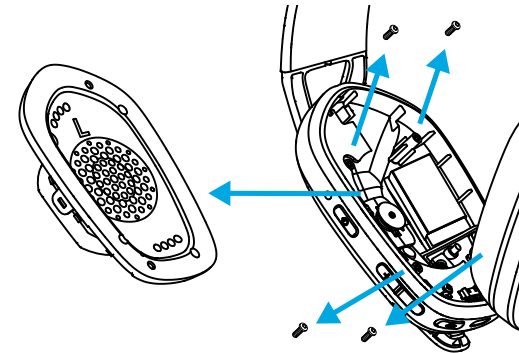

3

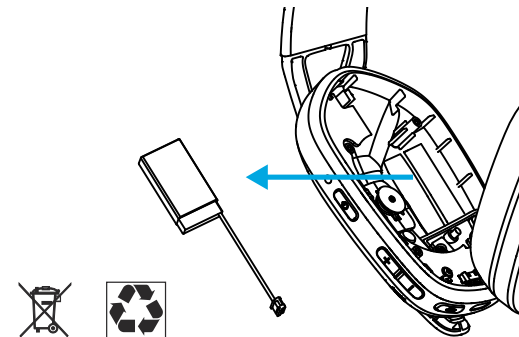

# CONEXIÓN LIGHTSPEED

Conecta a tu PC, Mac, PlayStation 5 o 4 con tecnología inalámbrica LIGHTSPEED

– Inserta el receptor en el puerto USB de tu dispositivo.

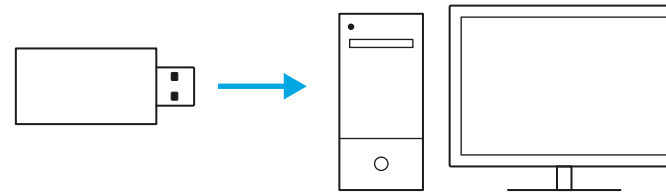

– Mantén presionado el botón de encendido un mínimo de 1,5 segundos.

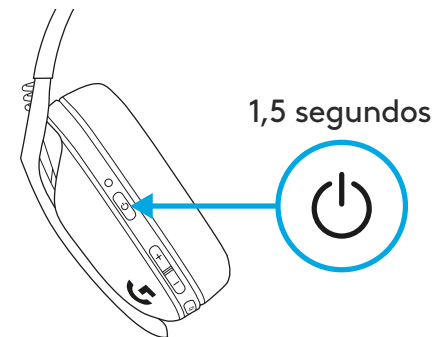

– El LED se vuelve **cian** una vez conectado.

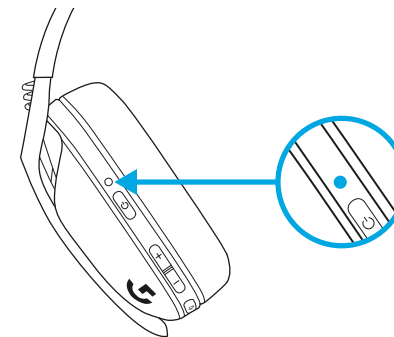

# CONEXIÓN *BLUETOOTH*

- Presiona 3 segundos o más el botón de encendido y de silencio.

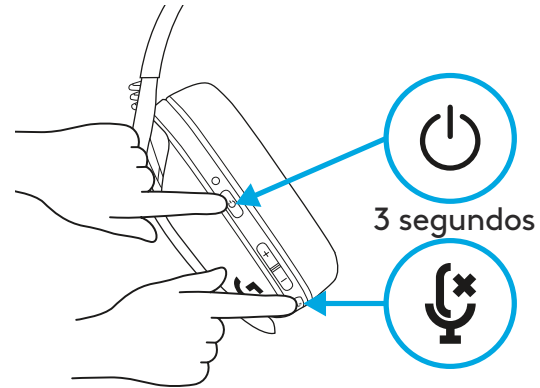

- El LED emitirá destellos **azules** al entrar en modo de emparejamiento.

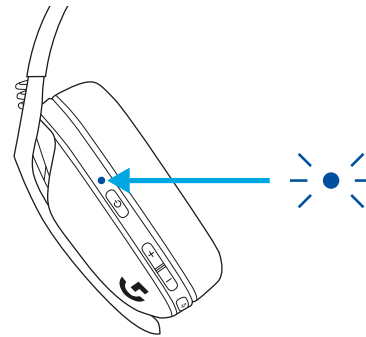

- Conecta a tu dispositivo preferido.

- Los audífonos G435 pueden conectarse a un único dispositivo *bluetooth* a la vez.

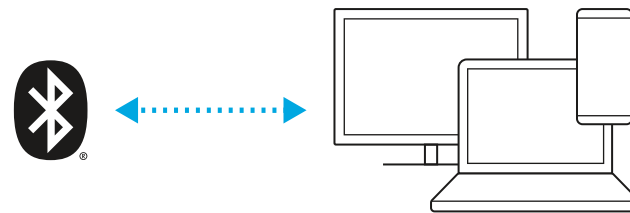

## ALTERNA ENTRE LIGHTSPEED Y BLUETOOTH

- Presiona 3 segundos o más el botón de silencio.

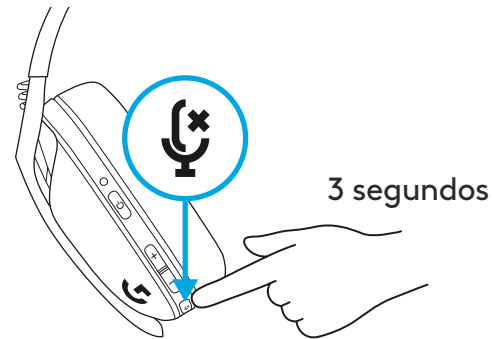

- Cambia a LIGHTSPEED, el LED se iluminará en **cian** por 5 segundos.

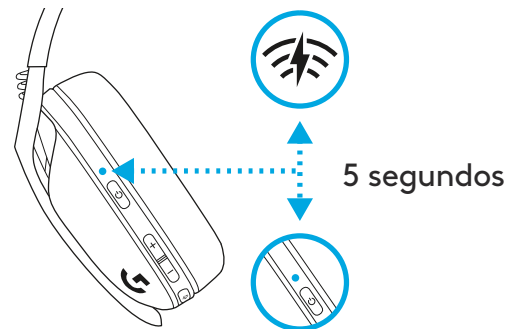

- Cambia a *Bluetooth*, el LED se iluminará en **azul** por 5 segundos.

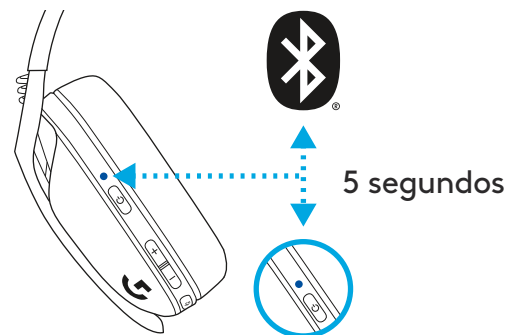

# ENCENDIDO Y APAGADO

## ENCENDIDO

- Presiona el botón de encendido por 1,5 segundos cuando los audífonos estén apagados.

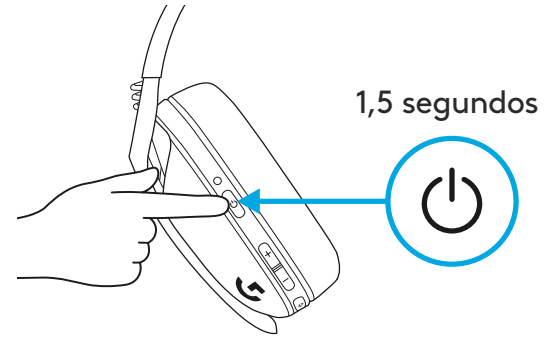

## APAGADO

- Presiona el botón de encendido por 3 segundos cuando los audífonos estén encendidos.

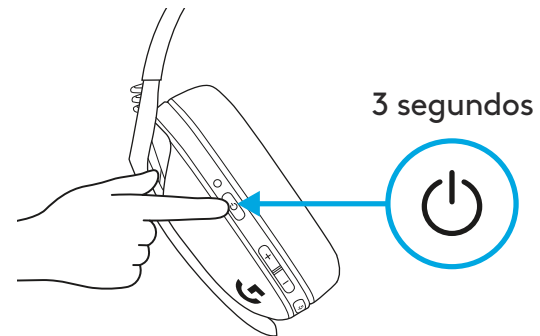

## Apagado automático

- Después de 30 minutos de inactividad.



# SILENCIAR/REACTIVAR SONIDO Y VOLUMEN MÁXIMO

## SILENCIAR/REACTIVAR micrófono

- Pulsación breve del botón de silencio.

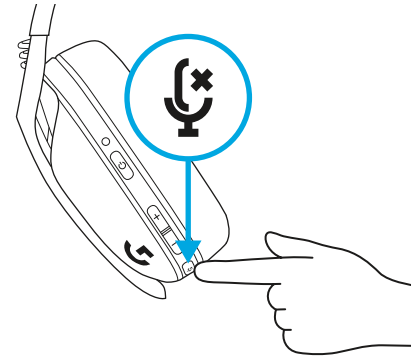

## Establecer volumen máximo

- Establecer a 100 dB
  - Presiona 3 segundos o más el botón de silencio + SUBIR volumen.
  - El LED emitirá destellos **naranja** 3 veces.

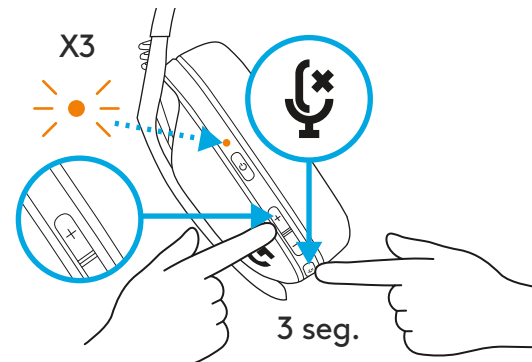

- Establecer a 85 dB
  - Presiona 3 segundos o más el botón de silencio + BAJAR volumen.
  - El LED se volverá **naranja** por 5 segundos.

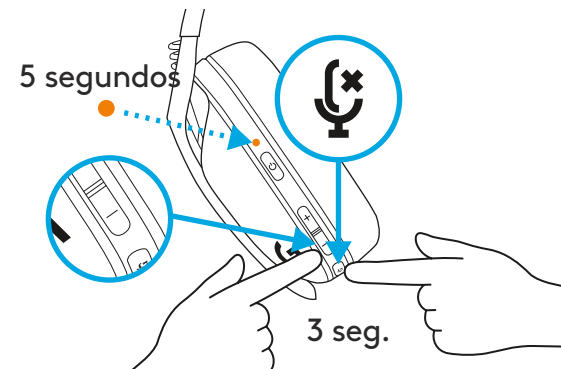

# COMPROBACIÓN DE CARGA

- Una sola pulsación del botón de encendido, con los audífonos encendidos
- Batería del 31% al 100% el LED se mostrará **verde** por 5 segundos.

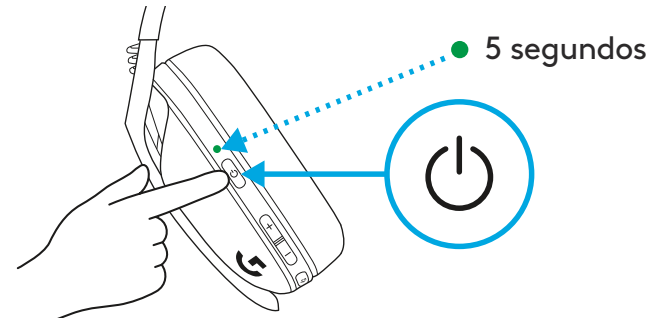

- Batería del 15% al 30% el LED se mostrará **rojo** por 5 segundos.

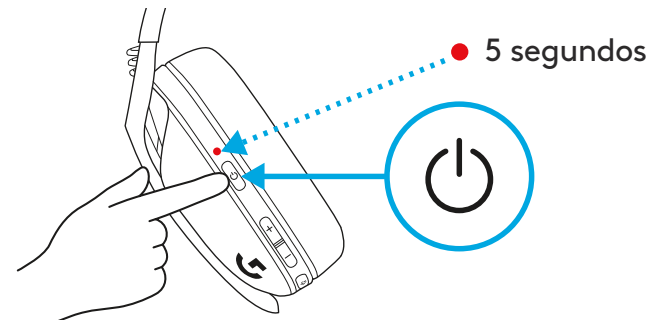

- Batería <15% el LED emitirá destellos **rojos** por 5 segundos.

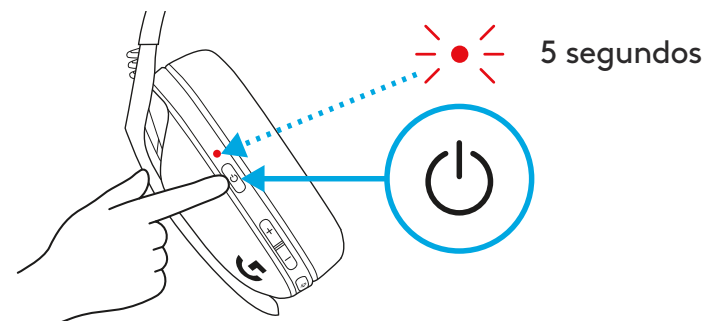

# TONO LATERAL

El tono lateral te permite oír tu voz mientras te comunicas con otras personas. Refleja la experiencia de hablar por teléfono y te permite ajustar tu volumen de habla a un nivel adecuado.

- Activar el tono lateral
  - Presiona dos veces el botón de silencio y el LED emitirá dos destellos en **naranja**.

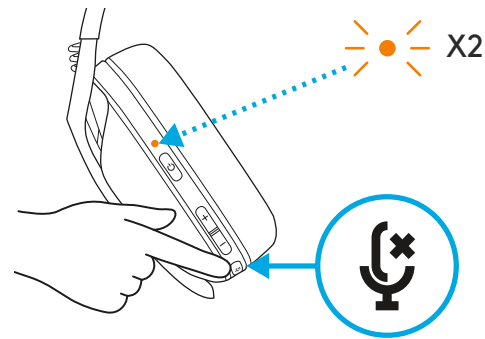

- Desactivar el tono lateral
  - Presiona dos veces el botón de silencio y el LED emitirá un destello en **naranja**.

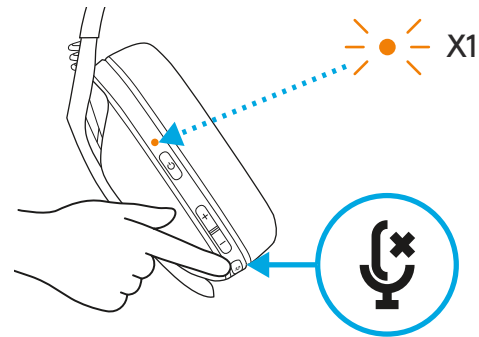

- Ajustar el tono lateral
  - SUBIR = Una sola pulsación del botón de silencio + SUBIR volumen.

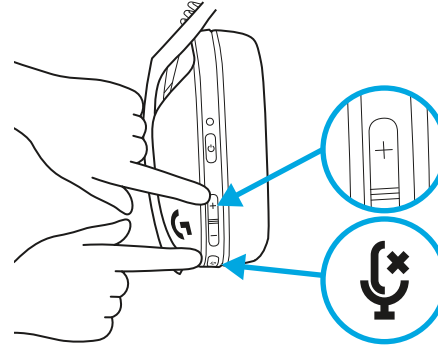

- BAJAR = Una sola pulsación del botón de silencio + BAJAR volumen.

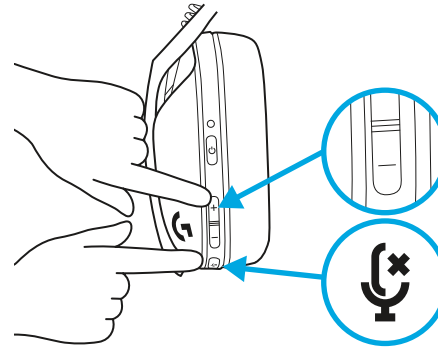

## PIEZAS DE REPUESTO

- Almohadillas
- Receptor USB inalámbrico
- Cable de carga

## RECICLAJE

Aconsejamos encarecidamente la reventa o donación de productos que aún funcionen. En caso de desecharlos, las baterías y los equipos eléctricos y electrónicos no se deben arrojar junto con la basura doméstica. Siempre que sea posible, deben separarse y llevarse a un punto de recogida pertinente para permitir el reciclaje y evitar posibles impactos en el medio ambiente y la salud humana. Para obtener más información, póngase en contacto con las autoridades locales o el lugar de compra, o visite [www.logitech.com/recycling](http://www.logitech.com/recycling)

## ¿PREGUNTAS?

[logitechG.com/support/G435](http://logitechG.com/support/G435)

## EXTRACCIÓN DE LA BATERÍA

1

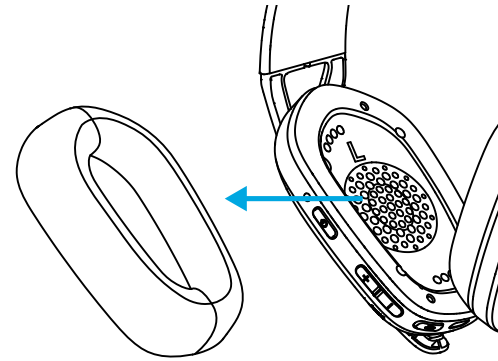

2

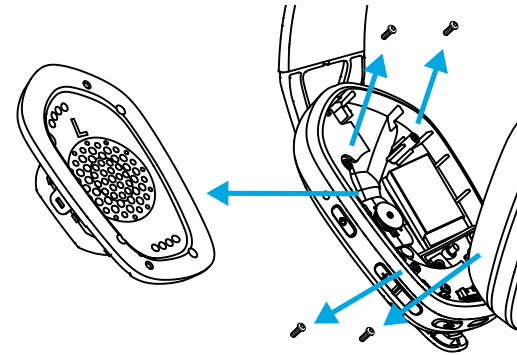

3

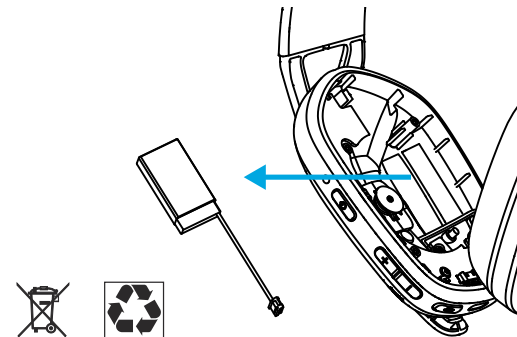

# CONEXÃO DO LIGHTSPEED

Conecte ao seu PC, Mac, PlayStation 5 ou 4 com a tecnologia sem fio LIGHTSPEED

– Insira o receptor na porta USB do seu dispositivo.

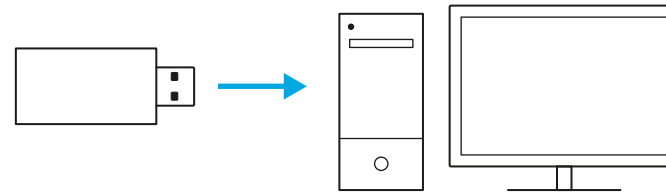

– Pressione o botão liga/desliga por no mínimo 1.5 segundo.

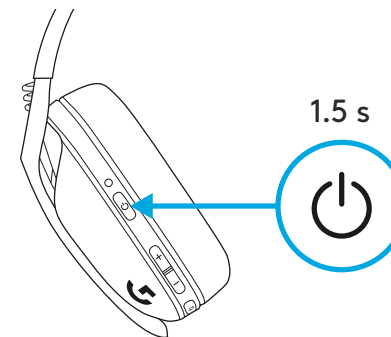

– O LED se torna **ciano** uma vez conectado.

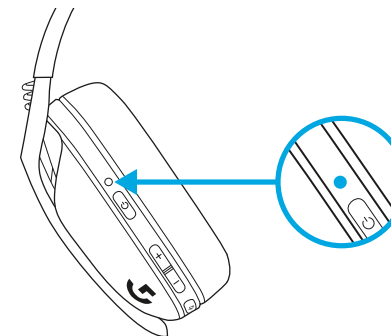

# CONEXÃO BLUETOOTH

- Pressione os botões Liga/Desliga e Mudo por três segundos ou mais.

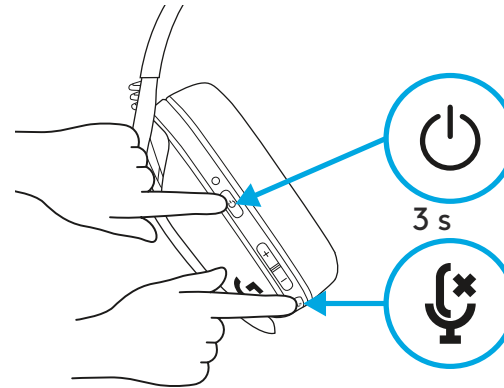

- O LED piscará em azul ao entrar em modo de pareamento.

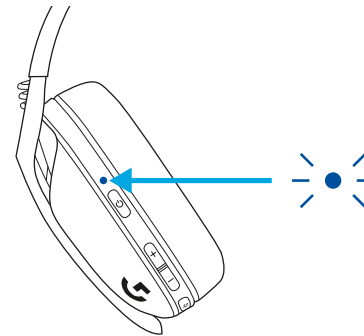

- Conecte-se ao dispositivo de sua preferência.

- G435 pode se conectar a um único dispositivo Bluetooth de cada vez.

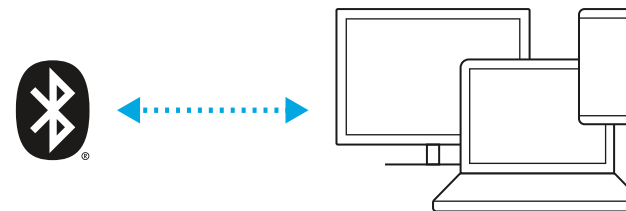

## ALTERNE ENTRE LIGHTSPEED E BLUETOOTH

- Pressione o botão Mudo por três segundos ou mais.

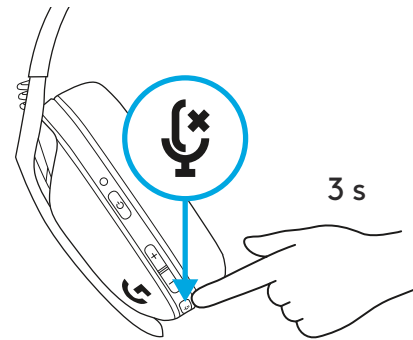

- Alterne para LIGHTSPEED, o LED acenderá em **ciano** durante 5 segundos.

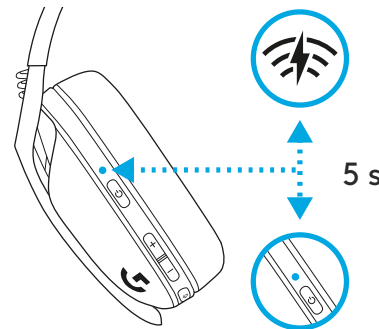

- Alterne para *Bluetooth*, o LED acenderá **azul** durante 5 segundos.

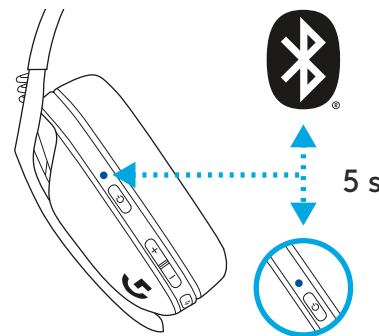



# LIGA E DESLIGA

## LIGAR

- Pressione o botão Liga/desliga por 1,5 segundos quando o fone de ouvido estiver DESLIGADO.

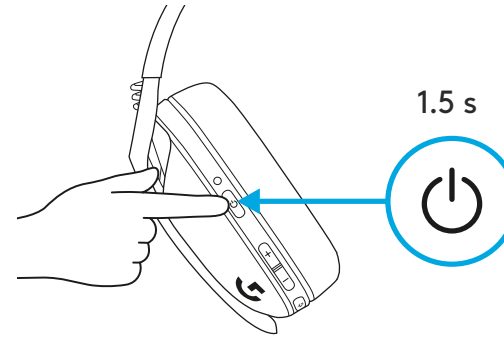

## Desligar

- Pressione o botão Liga/desliga por 3 segundos quando o headset estiver DESLIGADO.

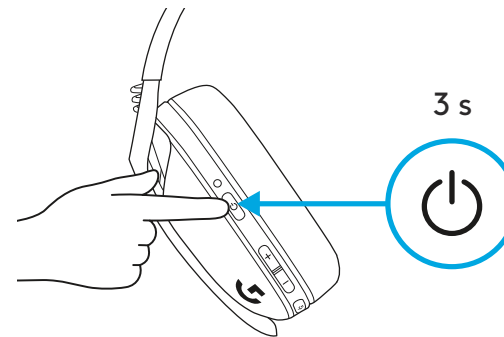

## Desligamento automático

- Após 30 minutos de inatividade.

# ATIVAR/DESATIVAR SOM E VOLUME MÁXIMO

SILENCIAR/ATIVAR som do microfone

- Pressione rapidamente o botão sem áudio

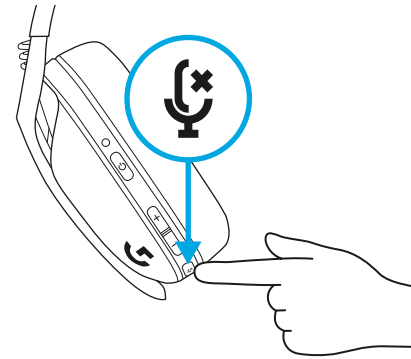

Definir Volume máximo

- Definir como 100 dB
  - Pressione o botão Mudo por três segundos ou mais + Aumentar volume.
  - O LED piscará em **laranja** 3 vezes.

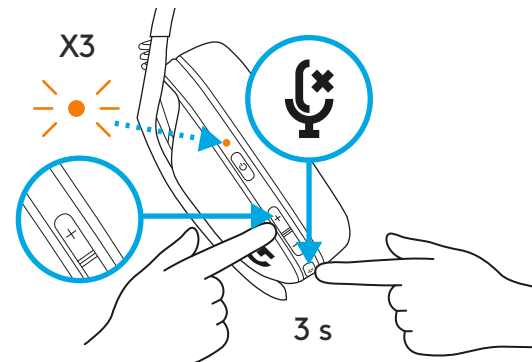

- Definir como 85 dB
  - Pressione o botão Mudo por três segundos ou mais + Diminuir volume.
  - O LED ficará sólido em **laranja** durante 5 segundos.

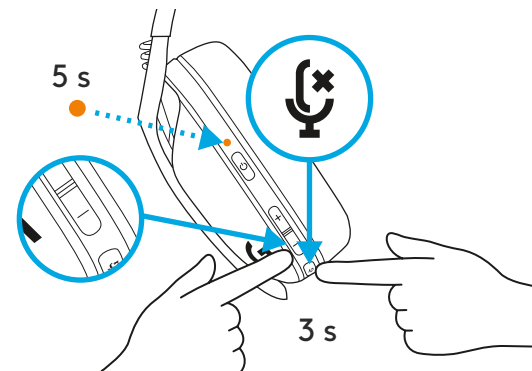

# VERIFICAÇÃO DA BATERIA

- Botão Liga/desliga, quando o fone de ouvido está ligado
- Bateria de 31% a 100%, o LED ficará **verde** por 5 segundos.

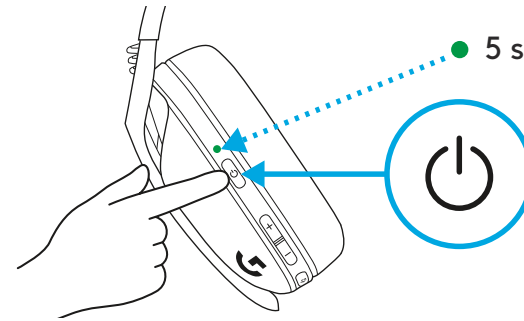

- Bateria de 15% a 30%, o LED ficará **vermelho** por 5 segundos.

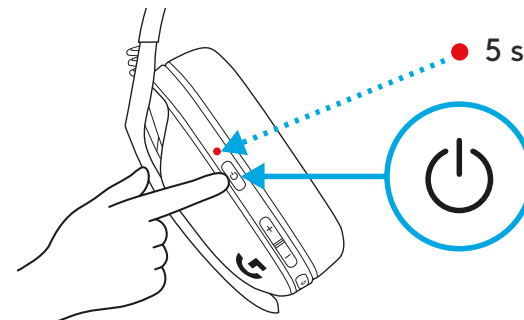

- Bateria com menos de 15%, o LED piscará em **vermelho** por 5 segundos.

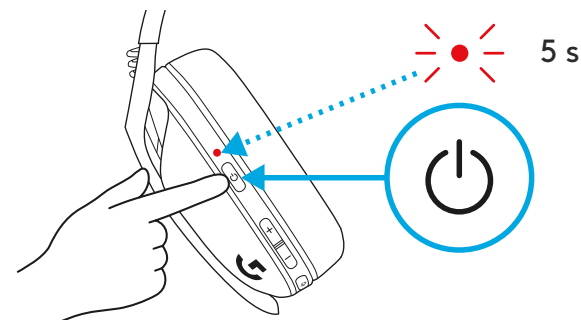

# SIDETONE

Sidetone permite que você ouça sua voz enquanto se comunica com outras pessoas. Ele reflete a experiência de falar ao telefone e permite que você ajuste seu volume de fala a um nível adequado.

## – Habilitar Sidetone

- Aperte duas vezes o botão Sem áudio e o LED piscará duas vezes em **laranja**.

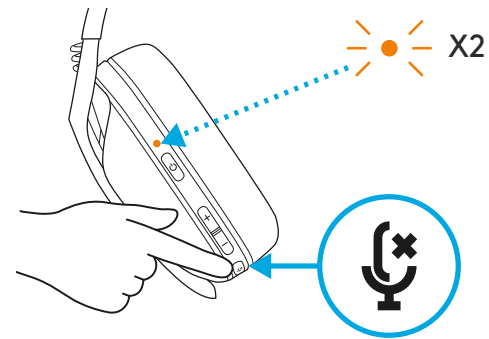

## – Desabilitar Sidetone

- Aperte duas vezes o botão Sem áudio e o LED piscará uma vez em **laranja**.

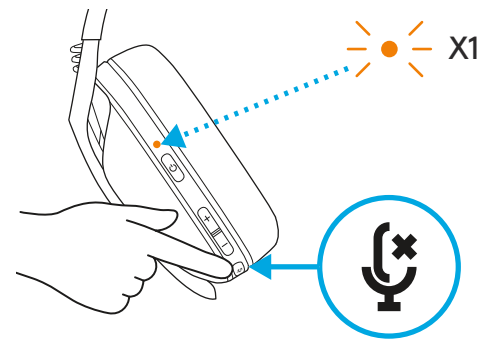

- Ajustar Sidetone

- Aumentar = Pressione uma vez o botão sem áudio + Aumentar volume.

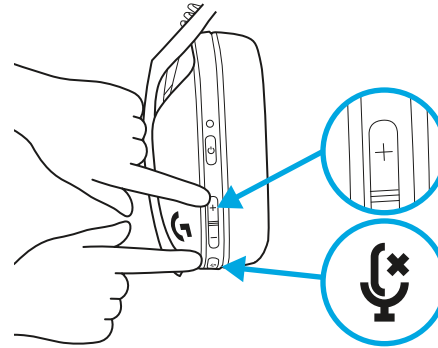

- Diminuir = Pressione uma vez o botão sem áudio + Diminuir volume.

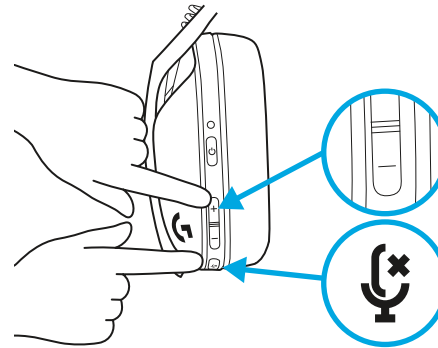

## PEÇAS SOBRESSALENTES

- Fones acolchoados
- Receptor USB sem fio
- Cabo de carregamento

## RECICLAGEM

Incentivamos você a revender ou doar produtos de trabalho. Caso contrário, baterias, equipamentos eletrônicos e elétricos não devem ser descartados com o lixo doméstico. Sempre que possível, eles devem ser separados e levados a um ponto de coleta apropriado para permitir a reciclagem e evitar possíveis impactos ao meio ambiente e à saúde humana. Para obter mais informações, entre em contato com as autoridades locais ou o local de compra, ou visite [www.logitech.com/recycling](http://www.logitech.com/recycling)

## ALGUMA DÚVIDA?

[logitechG.com/support/G435](http://logitechG.com/support/G435)

## REMOÇÃO DA BATERIA

1

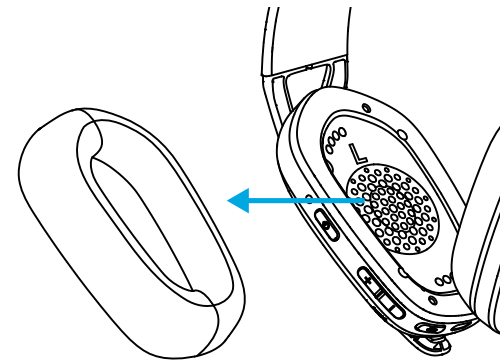

2

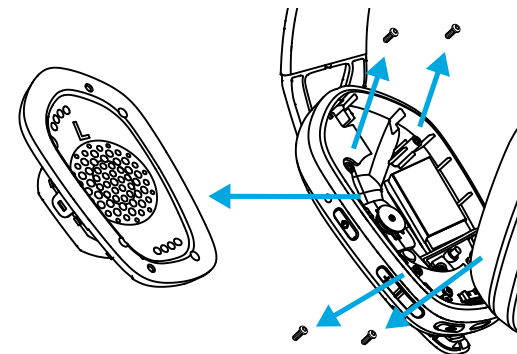

3

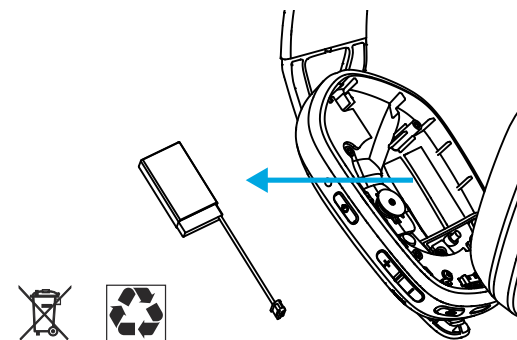



©2021 Logitech. Logitech, Logitech G, Logi and their respective logos are trademarks or registered trademarks of Logitech Europe S.A. and/or its affiliates in the U.S. and other countries. All other trademarks are the property of their respective owners. Logitech assumes no responsibility for any errors that may appear in this manual. Information contained herein is subject to change without notice.

©2021 Logitech. Logitech, Logitech G, Logi et leurs logos respectifs sont des marques commerciales ou déposées de Logitech Europe S.A. et/ou de ses sociétés affiliées aux États-Unis et dans d'autres pays. Toutes les autres marques sont la propriété exclusive de leurs détenteurs respectifs. Logitech décline toute responsabilité en cas d'erreurs susceptibles de s'être glissées dans le présent manuel. Les informations énoncées dans ce document peuvent faire l'objet de modifications sans préavis.

WEB-621-002085.002